

Index

1 Introduction

2 General

3 Precautions

- 3.1 Cable Handling
- 3.2 LED and Laser Precaution
- 3.3 Optical Fibre Handling Precautions
- 3.4 Material Safety
- 3.5 Safety During Installation
- 3.6 Personal Protective Equipment
- 3.7 Traffic Safety
- 3.8 Placing Equipment
- 3.9 Cable Protection and Reel Handling

4 Preparation for Cable Placing

- 4.1 Pre-Construction Survey
- 4.2 Pre-Construction Fibre Measurements

5 Unique Aspects of the Messenger Strand (Suspension Strand)

6 Tools and Materials

7 Types of Aerial Plant

- 7.1 Aerial Cable Lashed to a Messenger Strand
 - 7.1.1 Messenger Strands
 - 7.1.2 Moving Reel Method
 - 7.1.3 Stationary Reel Method
 - 7.1.4 Cable Lashing
- 7.2 Self-Supporting Cable
 - 7.2.1 Figure-Eight Cable
 - 7.2.2 Dead-Ends
 - 7.2.3 All-Dielectric Self-Supporting (ADSS) cable
- 7.3 Micro-duct cable used in aerial plant
 - 7.3.1 Micro-Ducts
 - 7.3.2 Micro-Duct Cables
 - 7.3.3 Jetting: Micro-Duct Cable Placing Method
 - 7.3.4 Micro-Duct Cable Jetting

1. Introduction

This practice covers the basic guidelines for installation of aerial Fibre-optic cable. It is intended for personnel with prior experience in planning, engineering, or placement of aerial cable. Pole line construction and strand installation are not covered in this document. A working familiarity with aerial cable requirements, practices, and work operations is necessary as this guide does not cover all aspects of aerial construction work.

Aerial optical cable is suspended in the air from poles and/or support structures. Most often it is supported between poles by being lashed to a wire rope messenger strand with a small gauge wire. The strand is tensioned to satisfactorily withstand the weight of the cable for the span length it will be used on plus any climatic loading such as ice, snow, and wind. The objective is to keep the cable in as low a state of stress as possible while maintaining sag in the messenger and cable that is safe and within limits as prescribed.

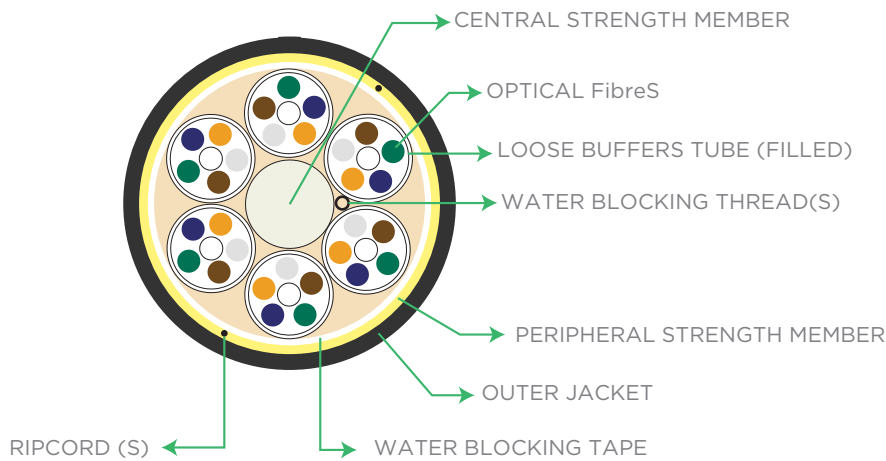

Figure 1- STL Duct-Lite™ Optical Cable for Lashed Aerial Applications

Some cables carry their own messenger and get their name from their shape, Figure-Eight Cables. The messenger is in the top portion of the figure-eight which has an extruded over jacket. The cable is supported from the messenger portion of the cable with a thin plastic web. As with the lashed cable, the messenger must be properly tensioned to resist the expected loading while keeping sag between supports safe and within acceptable limits.

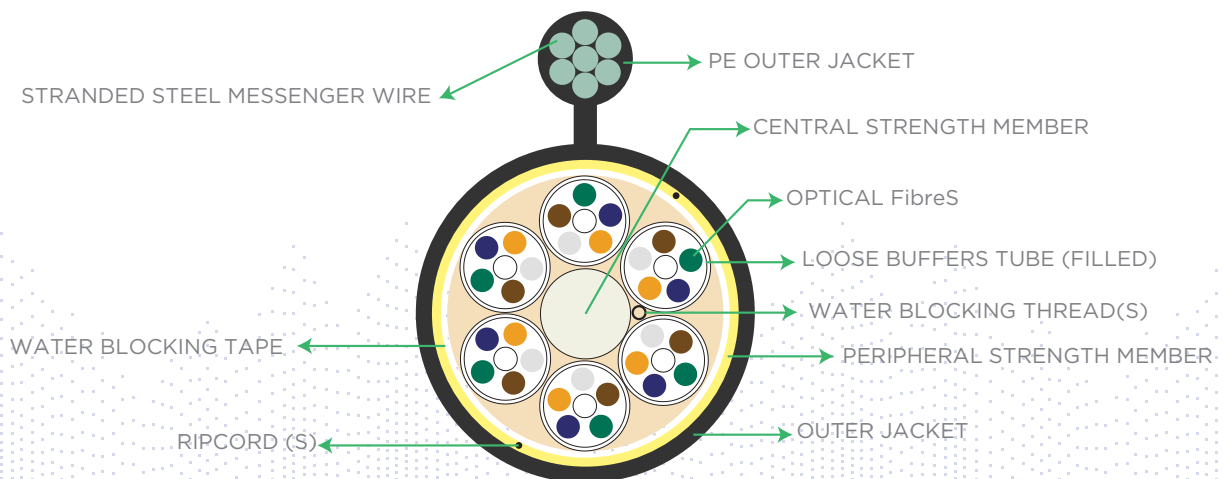

Figure 2- STL Loose Tube Figure-Eight weOight apt installilatlacnol Cable for Aerial Applications

The next type of aerial cable is an All-Dielectric Self-Supporting (ADSS) Cable with extra aramid yarn to provide its own support, eliminating the need for a messenger strand. ADSS cable is often used to span large distances when being supported off power utility towers. It is also popular when used near power utility lines as distribution plant.

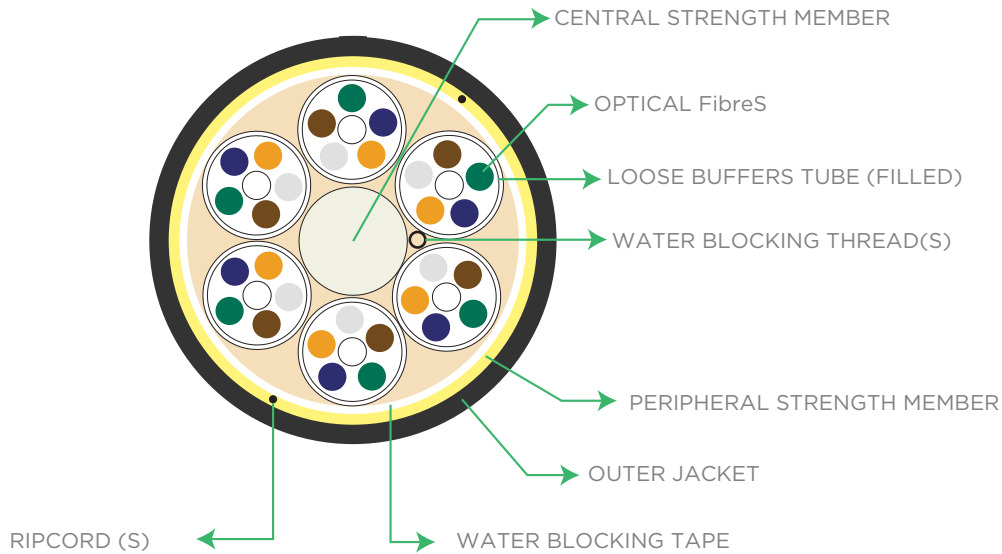

Figure 3- STL Aerial-Lite™ (ADSS) Optical Cable for Aerial Applications

The final optical cable covered in this document is a small diameter micro-duct cable, Micro DUCT-LITE™ Optical Cable. It has a cross-sectional diameter in the range from (6.0 mm) to 0.41" (18.0 mm) for cables ranging from 12 to 576 Fibres. Its cross-section consists of between 1 and 24 loose buffer tubes wrapped around a dielectric central strength member (CSM). It is an all dielectric cable so bonding and grounding issues are more relaxed. In its present configuration, it has a dry core and wet buffer tubes (filled with thixotropic water blocking gel).

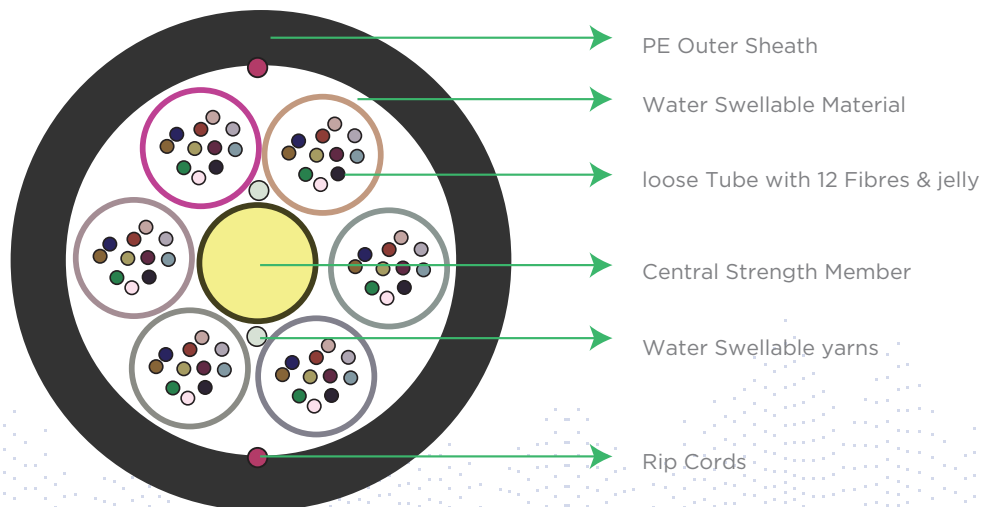

Figure 4- Cross-Section of STL's Micro DUCT-LITE™ Multitube Fibre Optic Cable

As is shown in Figure 5, a micro-duct cable provides a more compact packing for the Fibre in a cable half the weight of a conventional optical cable.

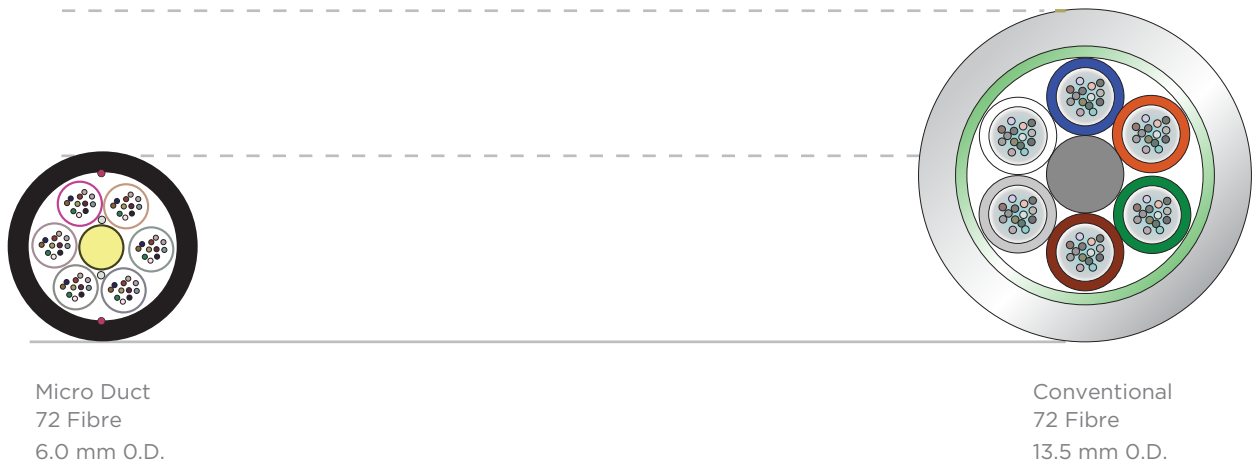

Figure 5- Comparison of STL's Micro-Duct Optical Cable to a 72 Fibre Conventional Optical Cable

The most common OSP uses of the different aerial cable designs are shown in Table 1.

Underground Plant	Urban	New Suburban	Old Suburban	Campuses	Rural
Messenger Strand	●		●	●	●
Micro-Ducts	●		●	●	●
Figure 8	●		●	●	
ADSS	●		●		●

Table 1- Commonly Used Aerial Plant Types for Various OSP Applications

● = Used often in this application

● = Can be used in the application under certain circumstances

Sub-ducts and micro-ducts are not used too frequently in aerial installations, but they are used occasionally when the placing operation cannot interrupt surface traffic or extra protection is required for the cable.

Micro-duct cable is blown (jetted) into the micro-duct. Normally, standard size Fibre optic cables can be pulled or blown into short lengths of aerial inner duct.

2. General

The aerial placing methods described in this document are intended as guidelines. National, state, local, corporate regulations and industry recommendations normally take precedence over the procedures contained herein. It is impossible to cover all the conditions that may arise during a placing operation. Individual company practices for placing Fibre optic cable should supersede any conflicting instructions in this document whenever they do not exceed the cable's optical and mechanical performance specifications. In addition, instructions provided by hardware manufacturers should be followed.

The methods used to place aerial Fibre optic cables are similar to those used to place copper cable. Optical cable is a high capacity transport medium that is sensitive to excessive tensile force, tight bends, and crushing forces, therefore, some care must be taken during the installation procedure to respect these limitations.

Fibre optic cables are ordered in lengths as calculated by an OSP (Outside Plant) Engineer to match the service route they will occupy. Their lengths are determined by measuring the distance between the splice points plus adding the excess length to reach the two splice locations and make the splices, and the required slack storage length for maintenance. In addition, extra length should be included in the ordered length to be available to cover errors are made during the splicing operation. If the excess splice length is not known, the splicing foreman should be consulted. Never cut a Fibre cable without first consulting the OSP Engineer responsible for the job.

3.0 Precautions

3.1 Cable Handling

All optical cables are sensitive to damage during shipping, handling, and installation. Some of the important parameters that need special attention during cable installation are:

- ◆ **Cable bending radius:** Optical Fibre cables are designed with a minimum bending radius and maximum tensile strength. The cable should never be bent below its minimum bending radius. Doing so can result in bending losses and/or breaks in the cable's Fibres. Generally the minimum bending radius of a Fibre cable under load is $20 \times D$, where D is the diameter of cable; the minimum bending radius of a Fibre cable under no load is $15 \times D$.
- ◆ **Cable Placing Tension:** Optical cables are designed with a maximum tensile strength. The cable should never be loaded beyond its maximum tensile strength. Exceeding this value provided by STL in the Cable Data Sheet / Specification, can alter cable and Fibre

3.2 LED and Laser Precaution

LEDs and lasers are used to test Fibre and transmission systems. They emit beams that are invisible to the human eye that can seriously damage the eye: Viewing these beams directly may not cause any pain and the iris may not close automatically as it would while viewing a bright light. As a result, the eye may not react to protect itself, resulting in increasing the chance of serious damage to the retina. Therefore,

- ◆ Never look directly into a Fibre end that has a laser or LED coupled to it.
- ◆ Never look directly into a Fibre end using any magnifying lens.
- ◆ If an eye is accidentally exposed to an LED or laser beam, immediately seek medical attention.

3.3 Optical Fibre Handling Precautions

Broken Fibre ends created during termination and splicing can be dangerous. These ends are sharp and can easily penetrate the skin. They invariably break off and are very hard to find and remove. Often tweezers and a magnifying glass are needed to remove them from the skin. Any delay in their removal could lead to an infection. Hence,

- ◆ Be careful while handling Fibres.
- ◆ Dispose of all Fibre scraps safely and properly.
- ◆ Do not eat or drink near the splicing area.

3.4 Material Safety

Fibre optic splicing and termination processes often use various chemical cleaners. The safety instructions developed for these substances should be followed. If there is confusion in the usage of these products, ask their manufacturer for a Material Safety Data Sheet (MSDS). Remember the following instructions while working with these chemicals.

- ◆ Always work in well-ventilated areas.
- ◆ Avoid skin contact with these cleaning materials as much as possible.
- ◆ Avoid using chemicals that causes allergic reactions.
- ◆ Isopropyl alcohol, used as a cleaner, is flammable and should be handled carefully.

Type of Exposure	Hexane		Isopropyl	
	Effect of Exposure	Emergency Treatment ¹	Effect of Exposure	Emergency Treatment ²
Inhalation	Irritation of the respiratory tract, cough.	Maintain respiration, bed rest.	Irritation of the upper respiratory tract.	Move victim to area containing fresh air. Administer artificial respiration if breathing is irregular.
Ingestion	Nausea, Vomiting, Headache.	Do not induce vomiting, immediately seek medical assistance.	Drunkenness and vomiting.	Have victim drink water and milk. Seek medical assistance.
Contact with Eyes	Irritation.	Wipe off affected area and wash with soap and water.	Harmless to skin.	Wipe off affected area of skin and wash with soap and water.
Contact with Skin	Irritation.	Wash eyes with plenty of water for 15 minutes.	Irritation.	Wash eyes with plenty of water for 15 minutes.

Table 2- Primary Treatments for Hexane and Isopropyl Exposure

3.5 Safety During Installation

Manhole/Underground Vault Safety:

- ◆ Explosive gases or vapors might be present in manholes or handholes due to gas leaking from nearby pipelines, tanks, or the soil. Before entering any manhole test its atmosphere with an approved test kit for flammable, explosive, and poisonous gases.
- ◆ Avoid usage of any device that produces a spark or flame in or near a manhole.

Working Safely:

- ◆ To minimize the risks of an accident in the work area, follow the existing rules for setting up warning signs, barricades, manhole guards, and cones.
- ◆ Before pulling cable directly from a figure-8 configuration, make sure that the area inside the loop of the cable (figure-8) is clear of personnel and equipment. Failure to do so may result in injury to the personnel or damage to the cable.
- ◆ Ensure that the tools and equipment used for the cable installation are in proper working order. Improperly functioning equipment may damage cables or cause injury to personnel.

¹Seek Emergency treatment for inhalation, ingestion, severe contact with skin, and contact with eyes.

- ◆ Be careful when working near electrical hazards, if electric lines are passing through or near the right-of-way where installation is being performed.
- ◆ Bond all metallic components in the underground system together. At all points where anyone may come in contact with the metallic components of the underground cable system, ground the bonded metallic components to a proper earth ground to avoid electric hazards produced by power lines or any other means.

3.6 Personal Protective Equipment

Placing optical cable and jetting micro-duct cable require sophisticated operations and use equipment that many placing crews may not be experienced with. As a result, STL recommends using a placing crew that is familiar with and has experience with the cable being placed and the procedures and equipment being used. Approved personal safety equipment, such as hard hats, safety shoes, safety glasses, reflective traffic vests, and gloves shall be used for all outside plant construction activities.

3.7 Traffic Safety

All applicable federal, state, and local departments of transportation regulations and codes shall be met including the use of safety equipment such as reflective safety vests, warning signs, barricades, and lighting if work is being performed during non-daylight hours. All traffic control requirements shall be met.

3.8 Placing Equipment

Most of the equipment used is more sophisticated than conventional placing equipment. High pressures are used to drive hydraulic motors as well as the use of high pressure air lines. If a failure occurs to a high pressure hose or connection, it is potentially dangerous to those working around the equipment.

Therefore, the placing crew needs to read, understand, and be familiar with all operating procedures as well the safety issues outlined by the placing equipment manufacturer.

3.9 Cable Protection and Reel Handling

- ◆ While loading or unloading cable reels, care must be taken to prevent collision with other reels, or damage to the reel or cable.
- ◆ The reel should not be rolled a long distance. If it is necessary to roll the reel, it should be rolled on both flanges in the direction indicated by the arrow on the flange.
- ◆ The reel should never be stored on its side.
- ◆ Cable reels should always be stored on a flat surface with blocks placed under both flanges to prevent rolling in either direction.
- ◆ The cable on the reel should be covered at the factory with a UV/thermal wrap until just prior to installation to protect it from exposure to the sun and high temperatures.
- ◆ The reel should never be dropped.

4 Preparation for Cable Placing

4.1 Pre-Construction Survey

One of the most important steps in the engineering and placement of optical cable is the pre-construction site survey. During this survey the placing supervisor and/or OSP engineer will be able to observe any unusual situations that require special attention. The proposed placing route will be evaluated for its ability to support the planned placing procedure. One of the main objectives of the survey is to discover all potential pit-falls in the proposed placing operation so they may be accounted for in the final procedure.

General Issues

- ◆ If possible, select a route that follows existing telecommunications infrastructure.
- ◆ Before any visit is made to a prospective construction site, develop an up-to-date plot plan showing the location of existing utilities to be obtained from each of these utilities that possible areas that may affect the construction operation. The plot plan shall be noted with details characterizing each utility and phone numbers to call if there are problems.

- ◆ Select a route that provides easy access for workers, equipment, and materials.
- ◆ The placing route shall have a spacious and safe staging area convenient to the job site.
- ◆ The staging area shall be a location in which cable reels can be unloaded and stored prior to use with an all-weather surface. It shall also be a location at which Fibre measurements can be made. It shall be secure from vandalism and theft.
- ◆ The job site and staging area shall be protected from both pedestrian and vehicular traffic. Splice locations shall be selected on the basis of their ability to serve as a good cable feed and/ or cable pulling location, as the location where Fibre branching occurs, and as an area capable of supporting the splicing operation.
- ◆ Placing operations in all types of plant (aerial, buried, and underground) is normally easier when done downhill. Try to configure the placing operation downhill.
- ◆ As optical cable is placed, care must be taken not to kink, distort, or crush the cable. The cable manufacturer's recommended minimum bend diameter shall be respected. If no diameter is recommended, use the following limits for the minimum bend diameter allowed for the cable.

Cable under no load, Minimum bend radius $\geq 15 \times$ Cable Diameter
Cable under load, Minimum bend radius $\geq 20 \times$ Cable Diameter

- ◆ All splice locations and points where human contact may result in exposure to metallic components in the cable, splice closures, or the cable infrastructure needs to be properly bonded and grounded to an earth ground.
- ◆ Sufficient space must be provided around the start of the cable placing operation to provide a gentle transition pathway for the cable from the reel to the aerial support system. Usually 50 feet of unobstructed space should be provided for the pulling equipment to enable an unobstructed and smooth cable transition.
- ◆ New construction must follow the National Electric Safety Code; OSHA Safety Requirements; and state, local, and federal guidelines.
- ◆ All placing operations require constant high quality communications for the entire operation. Radios are the most common means of communications for placing operations. The pre-construction survey should ensure that the radios will work properly in all locations that will be encountered during the installation.

Aerial Pre-Construction Survey

The bulk of the information about an aerial placement job will be obtained by the examination of past records on the same support structures and from the visit to the job site on the route survey.

- ◆ The overall condition of the support structures should be determined as well as the safe location on the structures for the new plant.
- ◆ The hardware setup on the support structure should be determined and the guying system for the poles and support structures must be evaluated for suitability with the new cable placing operation.
- ◆ Any vegetation issue needs to be determined and if possible corrected. Traffic problems need to be determined and any other situation that may require special action needs to be determined and rectified.
- ◆ Select splice locations that fit the cable logistics, and provide a safe and convenient location for placing, splicing, and repair operations. The equipment and cable reels should be stored in a safe and secure location, safe from vandalism or theft.
- ◆ Each splice point should be provided with sufficient cable slack to enable the splice to be made on the ground following the company's normal splice procedures. After cable placement, approximately 2-3 meters of cable will be cut off each cable end to be assured that no Fibres are encountered that was damaged from the placing operation.
- ◆ Normally an additional 15 to 30 meters of cable are required on the ground to make the splice. If this distance is to be determined more precisely, it is equal the height of the cable on the support structure plus the distance from the support structure to the location of the splice in its vehicle or tent. In addition, at least 5 meters of Fibre must be added to make the splice. Company policy shall be followed to determine the amount of extra cable to store as slack cable to enable maintenance operations on the cable route. Cable should be ordered with sufficient length to provide the slack required to make splices and to repair any cable that needs to be repaired.
- ◆ It is important to pick the proper location for the cable reel and placing equipment. The Stationary Reel Method cable reel must be carefully aligned with the first sheave on the support structure and positioned back about 50 feet from the first support structure. For cable mounted higher than 15 feet in the air, the cable reel shall be positioned approximately four times the distance back from the support as its height on the structure. As a rule of thumb, most aerial cable should have at least three aligned support structures before the first large misalignment is encountered.
- ◆ The cable needs to be dead-ended to the support structure at each of the following points:
 - At its ends
 - Cable line misalignment $\geq 20^\circ$
- ◆ Otherwise, if the cable line misalignment is less than 20° a tangent support can generally be used.

Table 3 provides recommended clearances between aerial plant and various infrastructure items.

Application	Clearance to Plant
Horizontal Clearance for Support Structures and Aerial Cable	
Fire Hydrants	4 feet (1.2 m)
Traffic Signal Pedestals	4 feet (1.2 m)
Curbs	6 inches (15 cm)
Railroad Tracks	15 feet (4.6 m)
Power Cables (≤ 750 v)	5 feet (1.5 m)
Vertical Clearance for Aerial Cable	
Roadways	18 feet (5.5 m)
Driveways to Residences	10 feet (3 m)
Entrances to Garages	10 feet (3 m)
Alleys	17 feet (5.2)
Pedestrian Walkways	8 feet 2.4 m)
Railroad Tracks (from top of rail)	27 feet (8.2 m)

Table 3- Horizontal and Vertical Clearance for Aerial Plant

4.2 Pre-Construction Fibre Measurements

Cable on all reels need to be inspected for damage as they are received. As a precaution and to avoid costly extra cable removal operations, all Fibres should be measured on the reel using an OTDR. Measurements on single-mode Fibre cables should be made at 1550 nm and 1300 nm. If discrepancies are found with respect to the factory “as shipped” test results on the cabled Fibre, contact STL Technical Support at the location provided in below.

5. Unique Aspects of the Messenger Strand (Suspension Strand)

The aerial messenger strand is designed to support the mechanical and environmental stresses that it and its aerial cable will experience. Its strength to weight ratio allows it to support cable between poles (or support structures) without having its Fibres over stressed or from experiencing excessive sag. To achieve this, the messenger strand’s installation tension must be adjusted sufficiently to offset the effects of span length, temperature, mechanical loading, and wind and ice. As a result, the Fibre in the cable it supports is capable of remaining nearly stress free, even when it is exposed to full design loads.

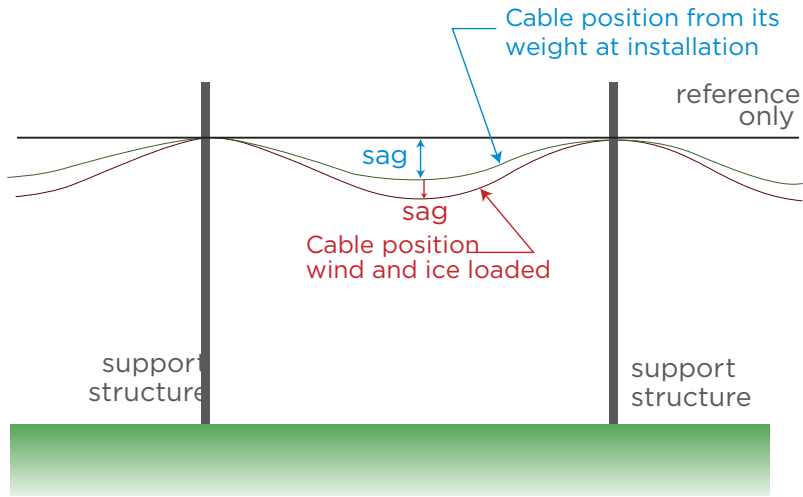

Figure 6- Sag Drawing of Aerial Plant Catenary Cable Deflection

The selection of the messenger strand, its placement, and its tensioning should be done following the standard operating procedures normally used by the communications company owning the plant. Standard hardware (eyebolts, clamps, etc.) and messenger strand installation procedures (pole framing, hardware placement, etc.) should be used, see United States Department of Agriculture, Rural Utilities Services, Bulletin 1751F-635.

The distance along the cable should be recorded on the construction prints at every other support structure (pole) and both of its ends.

Messenger strands used in aerial plant are rated by their breaking strength and the steel used in their construction. Some of the more common messenger strand sizes are listed below.

Messenger Strand Diameter (inches)	Steel Type	
	UG (Utility Grade)	EHS (Extra High Strength)
1/4"		✓
5/16"	✓	✓
3/8"	✓	✓
7/16"	✓	
1/2"	✓	

Table 4- Typical Messenger Strand Types

For general applications, contact STL Customer Service for a determination of the minimum stringing tensions for a particular cable and span length using different messenger strand grades.

CAUTION: Messenger strands can experience fatigue failure near pole-mounted suspension clamps if left under critical stringing tensions without supporting a load. Since all STL Fibre optic aerial cables weigh less than 0.3 pound/foot (0.4Kg/m), the messenger strand is essentially under no load. Contact the strand manufacturer to determine the critical tension for the specific strand being used. Frequently, by increasing the messenger by one or two sizes or by using vibration dampening weights on the span, the fatigue failure problem can be avoided.

The initial strand tension required depends on its size, the temperature at which the strand is tensioned, and on the average span length. There is a definite tension for each strand size - average span length at each temperature combination. Span mechanics calculations can be assisted using the United States Department of Agriculture, Rural Utilities Service (RUS), Bulletin 1751F-635, Section 5, Suspension Strand Tensioning. The initial tension and sag data for the installation of 6M, 10M, and 16M EHS Galvanized Steel messenger strands at various installation temperatures and average span lengths are given in Tables 1, 2, and 3 of RUS, Bulletin 1751F- 635. Tables 4-6 of the same document provide the maximum span length versus storm loading for various weight cables.

If STL Technologies is provided with the type and outside diameter (OD) of the messenger, the weight and OD of the optical cable, the loading district of the construction effort, the span length, and any other pertinent information, it can calculate the cable's sag and strain for the specific aerial installation. The recommended tensions and messenger types can also be generated for these applications.

When a messenger strand is used to support a Fibre optic cable, the most important concern is that the strand is strong enough and that the strain in the cable is acceptable. It is important to note that increasing the strands diameter also increases its weight. The effect of wind and ice is also increased by the larger sail area of the larger strand. The net result is increasing the strand diameter can also increase cable strain.

The aerial span from the last pole outside a building to a building is the only span which may have lower tension than the remainder of the aerial cable route. Installation technicians need to pay close attention in this span to ensure that the cable's minimum bend radius of is not exceeded.

6. Tools and Materials















Aerial cable placement is characterized by pulling or placing cables onto rollers (cable blocks) suspended off a messenger strand supported by poles or support structures. The messenger strand has been properly tensioned to provide sufficient supporting strength to keep the strain level in the cable low while experiencing maximum climatic storm loadings while maintaining minimum sag requirements for the cable structure. Traditionally the aerial cable is lashed to the strand by wrapping corrosion resistant wires around the combined cable/messenger strand system. Occasionally, inner duct is lashed to the strand and optical cables are pulled or blown in to the lashed aerial inner duct or self-supporting cables such as figureeight or ADSS cables are placed between supports without the use of a messenger strand.

Micro-duct cables can also be placed into micro-ducts which are housed directly in aerial inner duct that is lashed to the messenger strand. Placing equipment is specially tuned to be effective placing smaller microduct cables. Procedures and equipment are used to keep bending and tensile stresses under the mechanical threshold limits established for the micro-duct cable.

Table 5 and Table 6 provide a pictorial summary of the typical equipment and hardware used in placing aerial optical cables.

Table 5- Summary of Typical Aerial Plant Placing Hardware

Aerial Plant Placing Hardware

		
Messenger Strand	Lashing Wire	Synthetic Pulling Rope
		
D and E Lashing Wire Clamps GMP	Strand Vise	Wire Gripper GMP
		
Roller Type Cable Guide GMP	Single Lashing Aerial Cable Guide GM	Hand Line GMP
		
Aerial Handline GMP	Ground Rods GMP	Guy Hook
		
Guy Hook	Shackle	Thimble Eye Nut

Aerial Plant Placing Hardware



Thimbleye Bolt Jocyln



Dead End

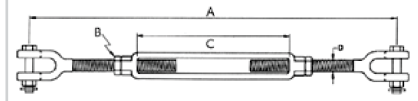

Turnbuckle



8" Snatch Block GMP



Starting Block GMP



In Line Block GMP



Cable Block with Rubber Roller



D Cable Block with Lifter GMP



Heavy Duty Fibre Block GMP



Pole Mount Fibre Block GMP



Figure-Eight Cable Web Slitter GMP



Figure-Eight Cable Clamp



Starting Block GMP



Wire Raising Tool with Poles GMP



GMP Strand Dynamometer

Aerial Plant Placing Hardware



Tangent Support



Tangent Support



Wire Raising Tool with Poles GMP

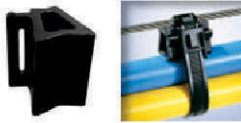

Cable Offset Spacer Allied Bolt



Cable Storage Bracket



Hand-Held Radio



Traffic Cone GMP



Safety Signs GMP

Examples of the special placing equipment and hardware that are used to place Fibre cable are shown in Table 6.

Table 6- Typical Placing Equipment Used to Place Micro-Ducts and Micro-Duct Cables

Underground Standard Fibre Optic Cable Placing Equipment

Pulling Winches



Portable Capstan Winch (GMP)



Trailer mounted Capstan Winch (GMP)



Side take-off winch with slip clutch (Condux)



Cable Reel Trailer (Plumett)



Cable Reel Brake



Line Truck



Cable Placing Truck (Canada)



Reel Truck

Micro-Duct Cable Placing Equipment



Arnco Dura-Line Plumett Cable Jet



GMP Air Stream

Fibre Optic Cable Placing Equipment



Dura-Line Air-Trak MD



Arnco Dura-Line Plumett SuperJet



Arnco Dura-Line Plumett Mini Jet



Arnco Dura-Line Plumett Maxx-Trak

Associated Materials and Equipment



Pull Line



Innerduct ENDOT



Duct Cutter



Duct Lubricant



Ball Bearing Swivel



Pulling Eyes for Sub-Ducts

Fibre Optic Cable Placing Equipment



Duct Plugs



Pneumatic Missiles
("Pigs" or "Birdies")



Large Diameter
Splittable Sheave



Manhole Sheave and
Quadrant Block (GMP)

Fibre Optic Cable Placing Equipment



Sheaves and quadrant
block in manhole



Pulling frame in manhole

7. Types of Aerial Plant

Three distinct variations in aerial plant types are described in this section. They all have cable supported in the air off a pole line or support structures. The following are the three types of aerial plant described:

- ◆ Aerial cable lashed to a messenger strand
- ◆ Self-supporting cable
 - Figure-Eight cable
 - All-Dielectric Self-Supporting (ADSS) cable
- ◆ Aerial micro-duct cable

Route planning and cable selection are technical considerations that are engineering and construction force responsibilities. The objective is to choose a method that imposes the least physical stress on the cable while providing a safe, cost effective solution to the placing problem.

7.1 Aerial Cable Lashed to a Messenger Strand

7.1.1 Messenger Strands

RUS Bulletin 1753F-152, Specifications and Drawings for Construction of Aerial Plant, RUS Form 515c Suspension Strand contains the following instructions for placing messenger strand.

- ◆ The cable shall be installed within a reasonable time after the messenger strand is installed and tensioned. If cable installation is delayed more than 24 hours, temporary dampers should be installed on the strand.
- ◆ When the messenger strand is tensioned, the strand suspension clamps shall be kept loose enough to allow free movement of the strand.

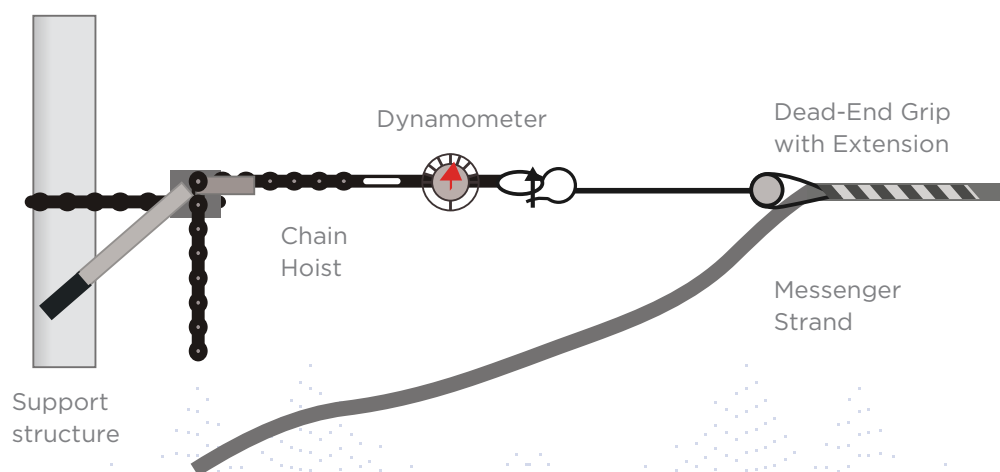

Figure 7- Tensioning the Messenger Strand Using a Dynamometer and Chain Hoist

- ◆ The messenger strand shall be placed in accordance with the work plan and tensioned in accordance with instructions, which are furnished, to the Contractor by the OSP Engineer.
- ◆ The messenger strand shall be placed on the roadside of the pole line unless otherwise directed by the OSP Engineer.
- ◆ In tangent construction, the lip of the suspension strand clamp shall point toward the pole. At angles in the line, the suspension strand clamp lip shall point away from the load.

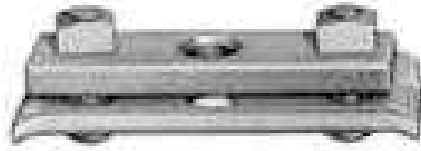

Figure 8- Suspension Clamp

- ◆ In level construction the messenger strand clamp shall be placed in such a manner that it shall hold the strand below the through-bolt. At points where there is an up-pull on the strand, the clamp shall be so placed that it shall support the strand above the through-bolt.
- ◆ When a thimble eye bolt is used both to mount the suspension strand clamp and to make the guy attachment, the size of the suspension strand clamp shall be governed by the size of the thimble eye bolt required for the guy.
- ◆ The air temperature at the time and place of tensioning the strand shall be determined by means specified by the OSP Engineer.
- ◆ The suspension strand shall be made electrically continuous throughout its entire length.
- ◆ Suspension strands shall be bonded to other bare cable suspension strands, and guys on the same pole and grounded by connection to ground leads at locations specified by the OSP Engineer and in the manner specified by the Engineer. Where the strand is to be grounded to a multi-grounded neutral on a pole which does not carry a vertical pole ground wire, a #6 AWG bare copper wire shall be left coiled and taped to permit it to be extended up the pole and connected to the multi-ground neutral by a representative of the power company.

RUS Bulletin 1753F-635, Aerial Plant Construction, Section 3, Suspension Strand Stringing contains the methodology for placing messenger strand.

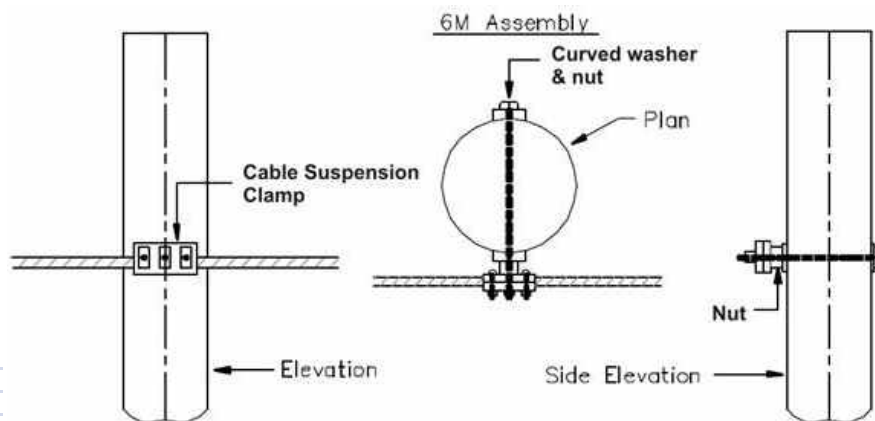

Figure 8- Suspension Cla**Figure 9- Messenger Stand Pole Attachment for Cable to Pole Angles 0° to 15°;**
(RUS 1751F-635)mp

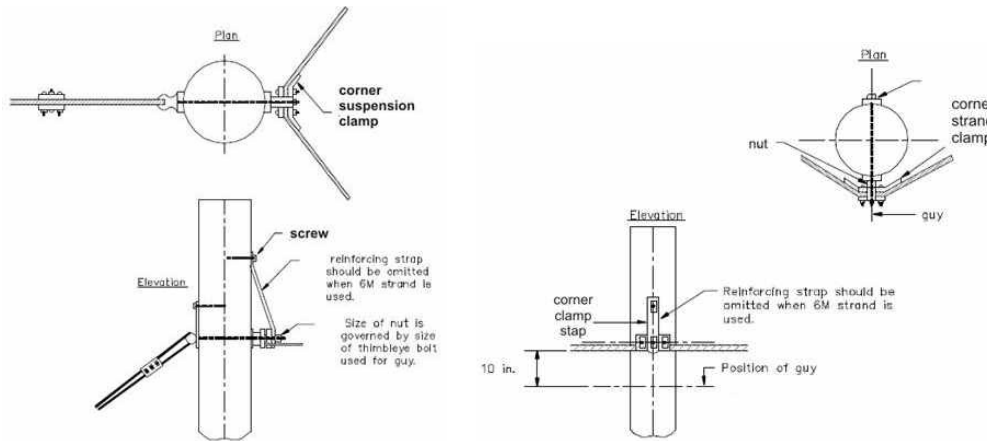

Figure 10- Corner Suspension Clamp Outside Angle 15° to 30° (left), Inside Angle (15° to 60°), (RUS 1751F-152)

There are two aerial cable placing methods that lash optical cable directly to messenger stands: stationary reel and moving reel method.

7.1.2 Moving Reel Method

In the moving reel or drive-off method, the cable is paid off the top of the cable reel which is carried by a moving vehicle as it drives along the pole line. When conditions are suitable, the moving reel method makes it potentially possible to increase productivity with its use. It is not as labor-intensive as the stationary reel method, in that it is not necessary to handle large numbers of cable blocks or sheaves and setup and cleanup time is shorter. Heavy tree conditions or right-of-way access problems, however, could slow progress with this method. Also, the moving reel requires that alignment of the reel and the cable chute be maintained. This alignment must be continuously monitored to prevent excessive bending in the cable.

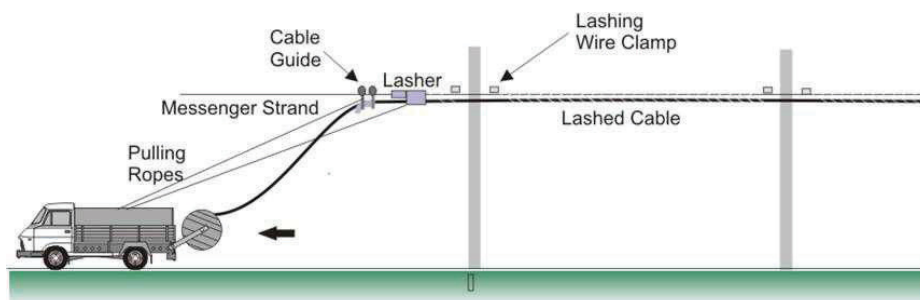

Figure 11- Schematic Drawing of the Moving Reel (Drive-Off Method) to Place Aerial Cable

7.3.1 Micro-Ducts

Traditionally, full-size underground optical cables have been placed in polyethylene sub-ducts often called inner ducts, nominally 25-51 mm in diameter. Inner ducts are located in conventional telecommunications duct systems, 75 to 100 mm inside diameter made of PVC, concrete, clay tile, or bituminous Fibre. Usually 3 to 4 inner ducts can be placed inside a 100 mm main conduit. One telecommunications standard size optical cable is generally placed in each inner duct. By using smaller diameter micro-ducts matched to the size of new, small diameter micro-duct cables, the telecommunications conduit system can be divided into many small, but secure, locations for the smaller diameter “micro-duct” optical cables. These micro-ducts can be placed in inner ducts, sub-ducts, or larger telecommunication conduits already in place in the OSP. A related multi unit product is produced by factory installing micro-ducts into new inner ducts or sub-ducts; alternately, micro-ducts can be factory installed into larger casings that group multiple micro-ducts into a flexible over-cased unit (see Figure- 43) which can be lashed to a messenger strand. These micro-ducts allow Fibre cable to be installed to match current service demands and spare duct space to be used at a later date to provide space to place new cables to match future demands when those demands arise.

Figure - 43 shows color coded micro-ducts that are either field installed or factory installed in inner duct and assembled as a multiunit over-cased structure.



Figure 44– Micro-Ducts Field Installed into Inner duct (right), Factory Installed in Inner duct (middle), and Factory Assembled into an Over-Cased Multi unit (left). (photograph courtesy A-D Technologies)

Micro-ducts provide the cables they house with additional mechanical protection at cable splice closures and in the OSP along their right-of-way. The protection includes the micro-duct or inner duct. Micro-duct can be purchased in different wall thicknesses and diameters to match the micro-duct cable used and the protection required.

In most cases, aerial use of micro-ducts and cable are specifically to exploit the extra protection from the encasing conduit or to provide an aerial pathway to place cable at some future time when the right-of-way may not be as accessible as it was at the time the micro-duct was lashed in place. Examples of micro-duct cable use in aerial plant are: road, rail, or river crossings and long spans between the supports.

The micro-ducts provide an air tight enclosure for the cables which enables air jetting to be used as a cable placing technique. The inside bore of many micro-ducts are coated with a low friction material to ease cable placing forces.

There are many micro-duct and sub-duct manufacturers that produce high quality, robust ducts that remain serviceable with good pressure resistance for future cable jetting installation many years after installation. These ducts are made from materials that will remain specially tuned for the micro-duct cable system and jetting procedure and remain stable for over 15 years.



Figure 42- Individual Micro-Ducts Available in Multiple Diameters (photograph courtesy A-D Technologies)

The individual micro-ducts are available in different diameters to match the cable diameter that they will contain. The ducts are also available in different wall thicknesses to match their intended use. Most often, micro-ducts are color coded to help identify their diameter. Most micro-ducts are made from HDPE and often they are lined with a low-friction material to assist in keeping placing loads low.

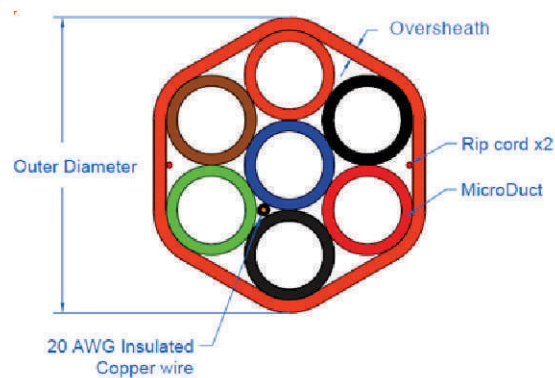

Figure 43- Multiple Micro-Duct Unit Available in Different Numbers of Sub-Ducts and Different Sizes (photograph courtesy A-D Technologies)

The individual micro-ducts in the multiduct unit are assembled in a factory and enclosed with an over sheath. As with individual micro-ducts, component micro-ducts are color coded with respect to their diameter.

Both individual micro-ducts and multiduct units are coiled on large reels in long lengths to match the job requirements.

10. Once a cable span from one dead-end support to the next temporary dead-end support is installed, that section of cable is tensioned to the tension level specified by STL for the cable size and weight, the span length, and the NESC loading area. Each dead-end segment is placed and tensioned sequentially until the entire cable is placed and tensioned. Once the cable segment (cable bounded by dead-ends) are tensioned, each intermediate support can be clamped in place on the cable.

7.2.3.3 Dead-End Procedure

STL recommends the use of cable hardware designed for STL's Aerial-Lite™ ADSS Cable applications manufactured by Dulmison or Preformed Line Products or equivalent products. Because of the different types of hardware available, it is necessary to select the proper materials for the cable design and route. In order to select the proper product, the installer must know the OD of the cable and the degree of offset from one pole to the next. In addition to dead-ends, it is important to also use the appropriate thimble clevis, extension link, and eye nuts. After the cable span has been properly tensioned, determine and mark the proper attachment location for the cable on the pole. Drill the appropriate clamp support holes or use a band attachment for concrete or metal poles to mount the supporting hardware. Refer to the manufacturer's recommended instructions to install all hardware. If vibration dampeners are required to resist wind induced vibrations, dampers should be installed following the manufacturer's instructions.



Figure 41- Vibration Dampener for ADSS Cable.

7.3 Micro-duct cable used in aerial plant

The micro-duct concept was developed to take advantage of the economics related to providing service to match telecommunication demand at the time the demand exists. The micro-duct system allows small diameter, very compact Fibre cables to be placed using modern, cost effective placing procedures in small diameter, protective micro-ducts located in underground conduits, direct buried in soil, or placed inside of sub-ducts lashed to aerial messenger strands. When new service develops, new micro-duct cables can be placed in previously installed spare micro-ducts. Since empty micro-ducts contribute little extra infrastructure cost at the time of the initial construction, they provide considerable flexibility and cost savings.

Micro-duct systems use small ducts and compact, small diameter Fibre cables to enable the unique microduct system to work. Figure 42 and Figure 43 show examples of micro-ducts and multiple chamber microduct units. In addition to the special ducts and cable, equipment specially tuned to place micro-duct cables in micro-ducts is available. This equipment will be briefly described in this Note; however, each manufacturer publishes instructions on how to use their equipment. The manual associated with the equipment being used should be read, understood, and consulted before any placing operation is attempted.

1. All of the key points for the moving reel placing method that were selected during the survey should be verified as satisfactory at the time of setup for the cable placing operation.

2. Sufficient slack must be provided at each splice point to enable the splice to be made and to provide for any cable maintenance. This slack length shall equal the height of the cable on the support structure plus the distance from the support structure to the location of the splice in its vehicle or tent. In addition, at least 5 meters of Fibre must be provided to make the splice. Company policy shall be followed to determine the amount of extra cable to store as slack cable to support maintenance operations. When the splice has been completed, the splice closure shall be safely mounted on the support structure and the excess cable shall be wrapped either around special storage frames or in neat coils and mounted on the existing cable near the splice closure. Special care is required to assure that the cable's minimum bend radius is observed during this process.

3. Several key issues will prove helpful during placement:

- ◆ For routes with significant change in elevation, it is easier to place the cable downhill.
- ◆ The entire operation will require clear and constant communication between all participants. A good two-way radio system is recommended. Communication needs to be established between the moving cable reel and observers located at key points along the cable route.
- ◆ If an intermediate feed point is required for long, or difficult, placements, use a figure-eight coil to store the cable for the second part of the pull. The figure-eight coil must be done carefully and cable should be coiled in an area 5 to 10 meters in size.
- ◆ The cable shall be pulled off the top of its reel during placement.
- ◆ The cable must not be allowed to rub on any of its cable reel flanges during placement. Smooth passage by the support structures of the cable shall be provided by carefully aligned Jhooks and/or cable blocks at each support.
- ◆ Sufficient technicians shall be available to monitor the cable placing operation. A person is required to monitor the cable reel, all dead-end locations, and all intermediate support points.

4. Before any placing operation is started, the cable shall be attached to the support structure at the start of the dead-end located at the first support pole.

5. Once everyone is in position and given a "ready to start" indication, the operation should be started at a moderate pace. Each observer shall be sure that as the cable passes their position, it is moving smoothly, unencumbered, and not rubbing over any hardware that could damage its jacket.

6. The cable payoff from its reel shall be controlled by the reel brake. The brake will be used to keep the cable from free-reeling off the drum or from jerky payout that causes spikes in the cable tension or in the worst-case situation, from throwing a cable loop. The cable payout should always be under slight braking. Care must be taken not to provide excessive braking, because it is possible to cause the cable's rated tensile load to be exceeded with too much braking.

7. After the placement starts, if a misalignment of the sheath or rubbing between the cable and reel occurs, the pull should be stopped and the problem corrected.

8. Placing tension for the cable shall be kept below the maximum rated placing tension specified by STL for that particular cable.

9. When the cable has been placed and held by its support structures, it shall be tensioned and affixed to the dead-end structure, see Figure 37. The cable is then removed from each of its intermediate supports and transferred to the clamps that will serve as its permanent support which will remain loose on the cable until the tensioning is completed.

7.2.3.2 ADSS Moving Reel with an Aerial Lift

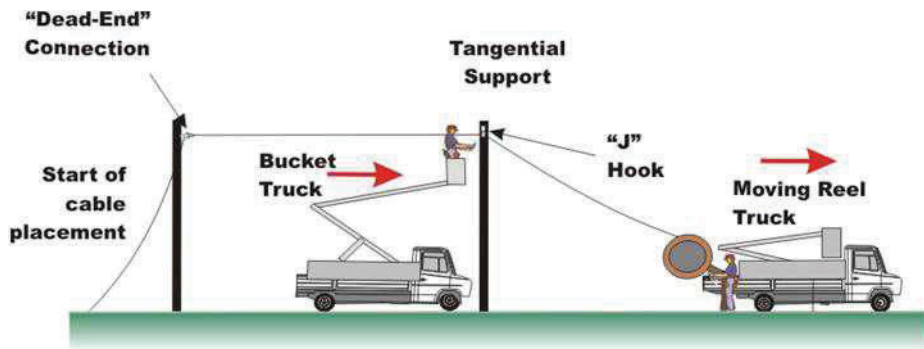

Figure 38- Moving Reel ADSS Cable Placing Method

In the moving reel or drive-off method, the cable is paid off the top of the cable reel carried by a moving vehicle as it drives along the pole line. As the vehicle passes each pole, the cable is raised into place by a technician in a lift bucket. The cable is placed into a "J" hook or block fitting bolted to the support structure for temporary support. This procedure continues as the cable reel moves along the cable line until a "deadend" pole is reached. A "dead-end" pole is either a start or ending support or a support in which the cable route is misaligned by 30° or more.

At this point, the cable is tensioned and terminated into "dead-end" fittings. The cable between "deadend" fittings is transferred from the permanent support at each of the intermediate poles and placed into permanent assemblies.



Figure 39- "J" Hook Used as a Temporary Support for ADSS Cable Moving Reel Placing Method.

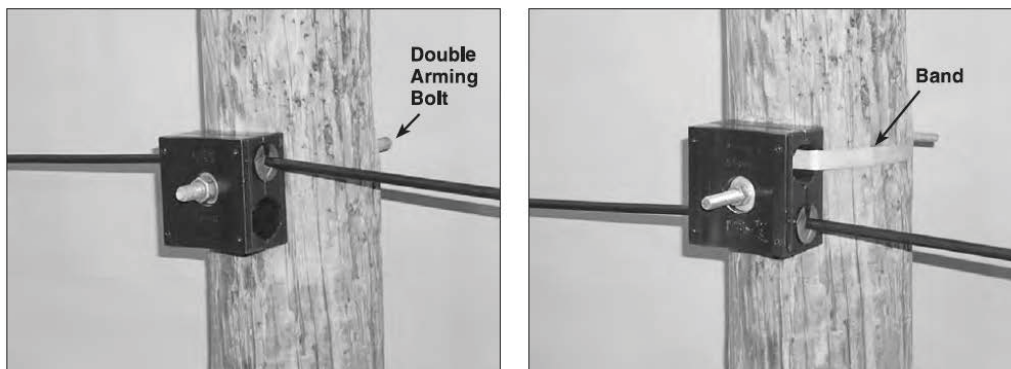

Figure 40- FibreLIGN® Lite Tangent Supports Bolt-Mounted (Left) and Band-Mounted (Right).

7. Placing tension for the cable shall be kept below the maximum rated placing tension stated by STL for that particular cable. If a winch line matched to the weight of the cable is used, the placing tension at the cable winch will approximately equal the maximum tension at the winch that was required to place the pull line.

8. When the cable reaches the location of the winch, do not allow it to pass around or interact with the winch unless the winch maintains the cable's minimum bend radius tensile strength.



9. When the cable has been pulled into place on its support structures, it shall be tensioned and affixed to each dead-end structure. The cable is then removed from each of its intermediate support (J hook or cable block) and transferred to the clamps that will serve as its permanent supports which will remain loose on the cable until the tensioning is completed.

10. The sequence in which the cable sections are tensioned and dead-ended is unimportant as long as a central pole is not converged upon from both directions by the tensioning operation.

11. Each dead-end segment is placed and tensioned sequentially until the entire cable is completed. Once the dead-ended cable segment is tensioned, each intermediate support must have its temporary support structure replaced by a permanent support.

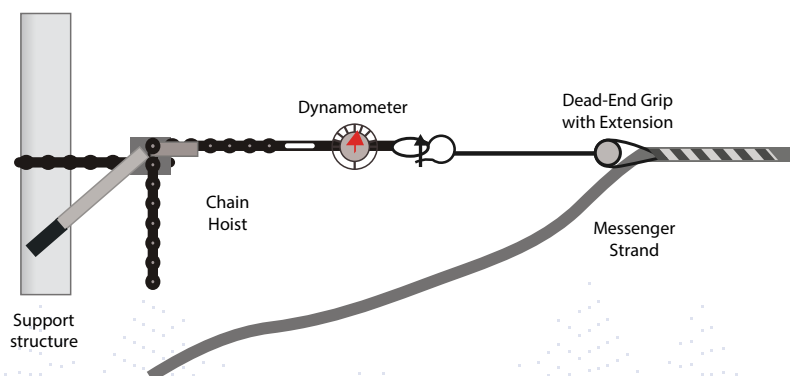

Figure 37- Tensioning of ADSS at Dead-End Support

- ◆ The connection between cable and winch line shall be made with a tension-limiting (fused), ball bearing type swivel. Vinyl tape shall be used to smooth the transitions along the surface of the pulling array.

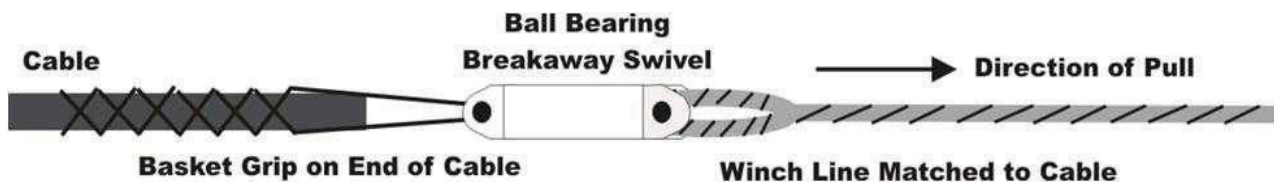

Figure 35- Cable Placement Array Using Ball-Bearing Swivel to Connect Winch Line to Cable

- ◆ The cable shall be pulled off the top of its reel during placement.
- ◆ Sufficient technicians shall be available to monitor all phases of the cable placing operation. A person is required to monitor the cable reel, winch, all dead-end locations, and all intermediate support points.

1. Sufficient slack must be provided at each splice point to enable the splice to be made and to provide for any cable maintenance. This slack length shall equal the height of the cable on the support structure plus the distance from the support structure to the location of the splice in its vehicle or tent. In addition, at least 5 meters of Fibre must be provided to make the splice. Company policy shall be followed to determine the amount of extra cable to store as slack cable to enable maintenance of the cable. When the splice has been completed, the splice closure shall be safely mounted on the support structure and the excess cable shall be wrapped either around special storage frames or in neat coils and mounted on the existing cable near the splice closure. Special care is required to assure that the cable's minimum bend radius is observed during this process.

2. The winch line shall be carefully fed through all the support hardware. The reel and the winch shall be positioned on opposite ends of the cable placing operation, approximately 50 to 60 feet from the support structure with which they respectively interact.

3. Before any placing operation is started, the cable shall be affixed to the support structure at the start of the pull using dead-end hardware.

4. Once everyone is in position and given a "ready to start" indication, the pull should be started at a slow rate. Each observer shall verify that as the cable passes their position it is moving smoothly, unencumbered, and not rubbing any hardware that could damage its jacket.

5. The cable payoff from the reel shall be controlled by the reel brake. The brake will be used to keep the cable from free-reeling or from jerky payout that causes spikes in the cable tension or in the worst-case situation, from throwing a cable loop. The cable payout should always be under slight braking. Care must be taken not to provide excessive braking, because it is possible to cause the cable's rated tensile load to be exceeded with too much braking.

6. After the pull starts and once the cable is determined to be moving without any misalignment with its support hardware, the speed of the placing operation can be gradually increased to 150 feet per minute. All observers need to continue to be vigilant for any problems. If a misalignment of the sheath or rubbing between the cable and support hardware occurs, the pull should be stopped and the problem corrected.

2. All of the key points for the stationary reel placing method that were selected during the survey should be verified as satisfactory at the time of setup for the cable placing operation. Locations for the cable reel and the cable winch shall be checked and all intermediate points shall be verified.

3. Several key issues will prove helpful during placement:

- ◆ For routes with significant change in elevation, it is easier to place the cable downhill.
- ◆ The entire operation will require clear and constant communication between all participants. A good two-way radio system is recommended. Communications needs to be established between the cable reel, the winch, and observers located at key points along the cable route.
- ◆ The cable reel needs to be located in an accessible area that is not encumbered with either pedestrian or vehicular traffic.
- ◆ If an intermediate feed point is required for long, or difficult, placements, use a figure-eight coil to store the cable for the second part of the pull. The figure-eight coil must be done carefully and should be coiled in an area 5 to 10 meters in size.
- ◆ Try to use the same reel location for the two adjacent cable placing operations.
- ◆ Cable alignment is absolutely necessary during the cable placing operation. The cable cannot be allowed to run over the edge or flange of any of the sheaves, travelers, or quadrant block frames. It also must not be allowed to rub on any of its cable reel flanges.
- ◆ Smooth passage between support structures and the cable/winch line shall be provided by properly aligned travelers, sheaves, and quadrant blocks.

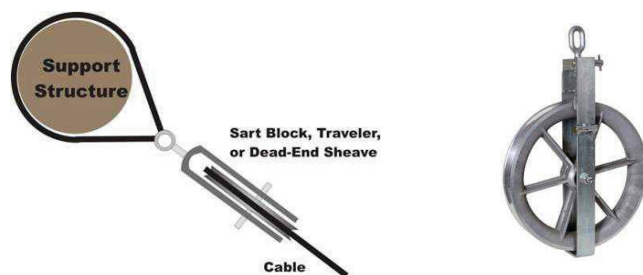

Figure 33- Supported Traveler or Large Diameter Sheave at Up-Feed and Down-Feed from Start and End Support Structures

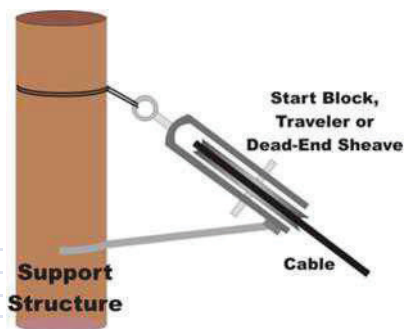

Figure 34- Supported Traveler or Sheave at Support Structure Positioned to Maintain Alignment with Cable

7.2.3 All-Dielectric Self-Supporting (ADSS) cable

ADSS cable can be placed using both the stationary reel and the moving reel methods. The moving reel method is the preferred method, if right-of-way is generally free of obstructions that would inhibit the movement of the cable reel. The moving reel method is much easier to setup and is more cost effective than the stationary reel method for self-supporting cable.

7.2.3.1 Stationary-Reel Method

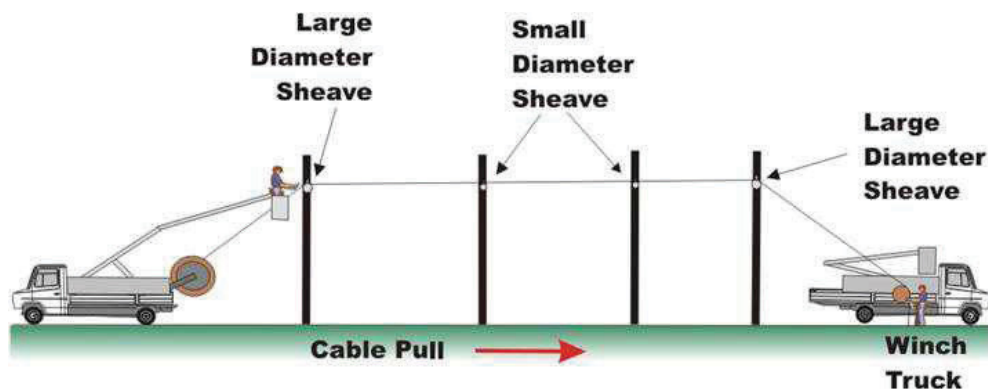

Figure 32- Stationary Reel Method: ADSS Cable Placement

This is a widely used method to place all types of aerial cable. For ADSS cable, the stationary reel method is often slower and more costly than the moving reel method, but can be used anywhere since it does not require an unobstructed right-of-way or vehicular access to the pole line. Higher costs are imposed by the difficulty of setting up and coordinating the pulling operation over the length of the cable route.

In this procedure, the cable reel is positioned at the starting end of the cable placement and positioned at least 50 to 60 feet from the first support to provide clear and unobstructed passage of the cable from the cable reel to the first sheave or quadrant block on the first cable support structure. The first sheave or traveler should have a radius at least 20 times the diameter of the cable being placed. A sheave shall be positioned on each support structure. Misalignments of 20° or more should be provided with a sheave having a radius at least 20 times the diameter of the cable being placed. Those supports in good alignment with the cable route should be equipped with a sheave having a radius at least 10 times the diameter of the cable being placed. The cable end shall be attached to a winch line of similar unit weight to the cable with a double-rotating, break-away swivel that has been threaded through the support sheave on each support structure.

A standard optical cable tension measuring and/or tension limiting cable winch shall be used to pull the cable into place. Placing hardware shall be positioned to provide clear and unobstructed passage for the winch line as it passes through the large diameter sheaves on the first and final cable support structures. After the cable has been pulled into position, transfer it from the temporary supports to the permanent cable supports as it is tensioned to the levels specified by STL Engineering to meet the expected maximum loading for its cable weight and span length.

1. The stationary reel method uses a placing procedure that can be compared to underground cable placing, but instead of placing cable underground into conduit, it is placed in the air suspended off supports at each support structure. The cable is pulled from support to support using a winch line similar in weight to the cable using a tension monitoring winch at the far end of the cable route and a fusible-link swivel as part of the pulling hardware. During the placing operation, the cable is supported by a temporary hardware on each pole. The supports consist of travelers, sheaves, and quadrant blocks.

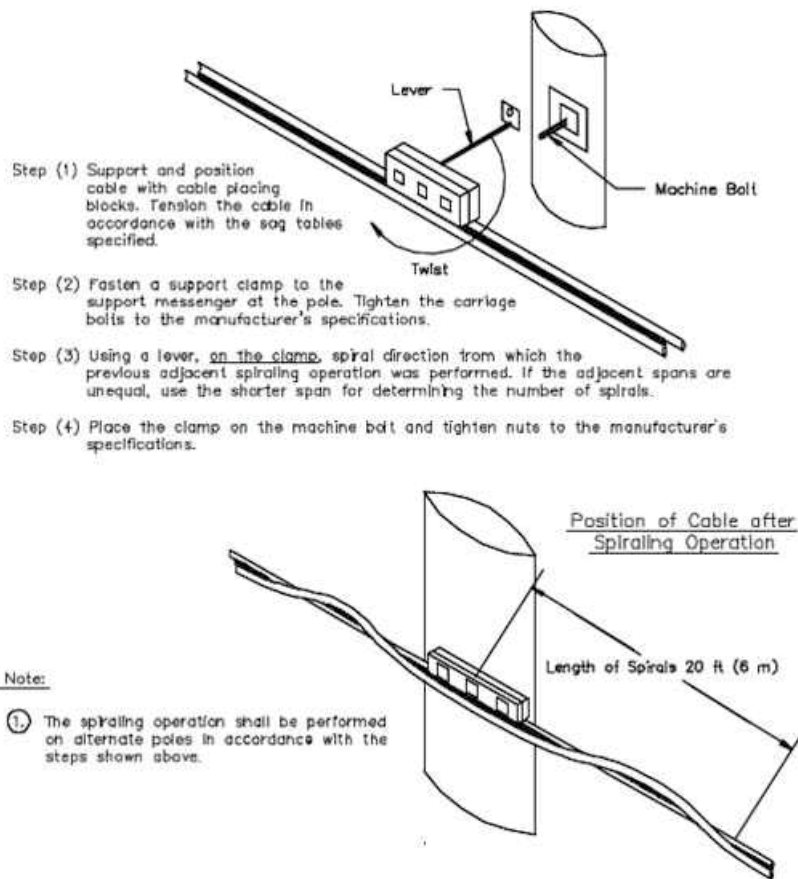

Figure 31- Spiraling Operation Detail, RUS 1753F-152

Stationary Reel Method

Where physical obstructions make it necessary to install self-supporting, Fibre optic cables using the stationary reel method, cables should be strung through cable blocks under a sufficient amount of tension to avoid excessive bending and to avoid unsafe sag between poles. The stationary reel method is made much easier if a messenger strand exists to suspend the required cable blocks. The blocks should be spaced approximately 35 feet apart. When using this installation method the maximum pulling tension and minimum bend radius of the self-supporting, optical cable should not exceed the manufacturer's recommendations.

Care should be exercised to prevent continuous spiraling from occurring during the stationary reel method installation of self-supporting Fibre cable. Since the cable will be spiraled by hand from alternate poles after tensioning, any existing spirals in the cable would be increased in one span and removed in the adjacent span. It would then be very difficult to obtain a uniform number of spirals in every span.

The initial sags and tensions for self-supporting, optical cables installed with various span lengths and at different temperatures in the three NESC storm loading districts should be obtained from STL. When tensioning self-supporting, optical cables, at intermediate support points, the insulation over the messenger strand should not be damaged. Tensioning by means of grips placed over the insulated support strand is the preferred method, provided that the tensioning can be accomplished without rupturing the insulation.

After placement, tensioning, and attachment to the pole structure, the cable is spiraled by hand from alternate poles; see Figure 31 for detailed instructions.

7.2.2.3 Figure-Eight Placing Procedure

Figure-eight cable can be placed using both the stationary reel and the moving reel methods. The moving reel method is the preferred method, if right-of-way is generally free of obstructions that would inhibit the movement of the moving cable reel. The moving reel method is much easier to setup and is usually more cost effective than the stationary reel method for self-supporting cable.

If the moving reel method is used, the cable is suspended off temporary blocks at each support structure (pole); no other hardware is required. If the stationary cable method is used, it requires that a messenger strand is available to support cable blocks every 35 feet to temporarily support the figure-eight cable until it is tensioned and attached to the poles.

The installation of self-supporting, Fibre optic cables should begin only after the support infrastructure is properly guyed and has been completed and capable of resisting the weight and tensile load it will receive during and after cable placement.

Self-supporting, Fibre optic cables should be installed using the moving reel method whenever possible. It should be placed using cable blocks on the poles where it will remain during the remainder of the placing and tensioning operations. As with all placing methods, the maximum pulling tension and minimum bend radius of the cable should not exceed the manufacturer's recommendations.



Figure 30- Two Types of Cable Blocks: Clip on Strand (Left) and Bolt to Pole (Right)

The messenger portion of the self-supporting, optical cable should be tensioned with the use of a dynamometer. Figure 8 shows a similar operation in which the messenger strand is being tensioned. Figure-eight cable tensioning is similar except it has an optical cable under the messenger being tensioned. The cable should be temporarily supported at each pole on rollers until after the cable has been tensioned at all dead-end poles and the tensioned equalized in all spans of the section being placed. Tension should be applied slowly while the entire length of cable being installed is observed for evidence of snagging or failure to move freely through its temporary supports at the poles.

The initial stringing tension for the cable will depend on the size of its support strand, the size of cable, the NESC storm loading district for the construction project, the span length, the temperature at the time of tensioning, and STL's recommendations.

After placement, tensioning, and attachment to the pole structure, the cable is spiraled by hand from alternate poles following the instructions found in Figure 31 (as found in RUS 1753F-152).

7.2.2.2 Strandvise

Another type of dead end is a strandvise. This type of dead end grips the messenger by using a compression sleeve cartridge when installed on the messenger. The sleeve cartridge slips into a yoke and bail to produce a dead end fitting which can be hung on guy hooks.



Figure 29- Aerial Strandvise Dead End

The strandvise type dead-end has a spring-type compression sleeve to grip the bare messenger strand.

NOTE: The cartridge sleeve can be removed from the yoke and bale. The cartridge shall not be reused although it is possible to reuse the yoke and bale if they are not damaged or corroded.

The strand vise should be used with a guy hook. Install a strand vise dead-end on a figure-eight cable as follows:

1. Determine where on the cable strand the strand vise will be mounted, then mark that location on the strand portion of the cable.

- ◆ If you are installing the dead-end at the end of a cable span or providing slack for a future splice point (prior to beginning the cable installation) allow for the appropriate slack requirements.
- ◆ If the dead-end is being installed on a tensioned cable at its installation level, ensure that the span is properly tensioned. Support the figure-eight cable extending beyond the dead end location to prevent damage from bending and or tension once the messenger is cut.

2. Separate the two figure-eight cable components with a web splitter or splicer's knife, starting about 11 inches (27.5 cm) ahead of where the messenger will enter the strandvise. The component separation length may vary with different strandvises. The actual length can best be determined by holding the strandvise you are using alongside the cable.

3. Determine the strip length required to fit both the messenger component into the strandvise and provide sufficient length for a bonding/grounding clamp to be clamped on the exposed end(s) of the strand. At least 3 inches (7.5 cm) of stripped messenger should extend out of the strandvise. Finally, cut the messenger strand to length with a pair of bolt cutters.

4. Remove the jacket from the messenger component of the figure-eight cable by running a splicer's knife along the strand. Peel the jacket away from the strand. Perform this step with care to avoid personal injury and to avoid any damage to the anti-corrosive zinc coating of the strand.

5. Slide the bare messenger strand into the strandvise cartridge assembly as directed by the strandvise manufacturer's instructions.

6. Use weather resistant cable ties or straps to connect the separated stand and cable and to keep the separation from propagating along the cable

7. Use a weather proofing tape around the strand at the point where the jacket is stripped off of the messenger to seal the jacket.

The portion of the wires between the two legs forms an eye when the grip is installed on the messenger. This type of a grip can be used to terminate a messenger strand at a dead end onto a guy hook. The strand grip manufacturer's instructions should be followed when it is used on the figure-eight cable.

Prior to the use of the wrapped strand grip the dead-end pole and figure-eight cable shall be prepared as described in the following steps:

1. Determine where on the cable strand the wrap strand grip will be mounted and mark that location on the strand portion of the cable.

- ◆ If you are installing the dead-end at the end of a cable span or providing slack for a future splice point (prior to beginning the cable installation) allow for the appropriate slack requirements.
- ◆ If the dead-end is being installed on a tensioned cable at its installation level, ensure that the span is properly tensioned. Support the figure-eight cable extending beyond the dead end location to prevent damage from bending and or tension once the messenger is cut.

3. Separate the two figure-eight cable components with a web splitter or splicer's knife, starting about 11 inches (27.5 cm) ahead of where the messenger will enter the strand grip. The component separation length may vary with different strand grips. The actual length can best be determined by holding the strand grip you are using alongside the cable.

4. Determine the strip length required to fit both the messenger component into the strand grip and provide sufficient length for a bonding/grounding clamp to be clamped on the exposed end(s) of the strand. At least 3 inches (7.5 cm) of stripped messenger should extend out of the strand grip toward the pole. Finally, cut the messenger strand to length with a pair of bolt cutters.



Figure 28- Strand Bonding Clamp

5. Remove the jacket from the messenger component of the figure-eight cable by running a splicer's knife along the strand. Peel the jacket away from the strand. Perform this step with care to avoid personal injury and to avoid any damage to the anti-corrosive zinc coating of the strand.

6. Assemble the strand grip on the stripped portion of strand according to its manufacturer's instructions.

7. Use a weather proofing tape around the strand at the point where the jacket is stripped off of the messenger to seal the jacket.

8. Use weather resistant cable ties or straps to re-connect the separated stand and cable and to keep the separation from propagating along the cable

NOTE: Strand grips should not be reused.

7.2.1 Figure-Eight Cable

7.2.1.1 Separating Figure-Eight Cable Components

The messenger portion of the figure-eight cable must be separated from the cable portion at a splice closure to properly terminate the cable and to splice the Fibres. The two portions of the figure-eight cable can be separated at the web using a web splitting tool (GMP® model # 82730 Web Splitter, or equivalent) or a splicer's knife and then pulling both portions apart.



Figure 26- GMP Model #82730 Web Splitter

- ◆ The tool is used by positioning its blade over the web at the point to be split. Squeeze the handles of the tool to have its blade penetrate the cable web. Pull the tool along the web causing it to separate the messenger and cable portions of the figure-eight cable. Up to 150m of cable can be separated with this type of tool.

7.2.2 Dead-Ends

Dead-end poles are the anchor points for the tensioned messenger at the start and end points of each cable. They are also used at supports in which the intersecting cables are greater than 30°. The messenger strand is fixed to dead-end poles with dead-end fittings which maintain the tensile loading of the span. The following paragraphs describe two basic types of dead-end fittings: strandvises and strand grips (wrap type).

7.2.2.1 Wrapped Strand Grip Dead Ends

Dead ends transfer the strand tension from the messenger strand to the support structure (pole). A typical wrapped dead end consists of spirally formed high strength steel wires which are wrapped around the bare messenger strand.



Figure 27- Wrapped Strand Grip Dead Ends

7.2 Self-Supporting Cable

The cable placing operations described in this section do not use a messenger stand as part of their installation hardware. The cables are supported by strength members that are designed into their cable sheaths as part of the cable design. Two types of cables, Figure-Eight and All Dielectric Self-Supporting (ADSS) Cable, are cables that comprise this family of cables. The actual installation method for both types of cable is similar, but because the cables are configured somewhat differently, the support hardware is similar in function, but somewhat different in design.

Figure-eight cables carry their own messenger and get their name from their shape. The messenger is in the upper portion of the cable. It has an extruded over jacket. The cable is supported from the messenger portion of the cable with a thin plastic web. As with other lashed cable, the messenger portion must be properly tensioned to resist the expected loading while keeping sag between safe and within acceptable limits. The next type of self-supporting cable is an all-dielectric self-supporting (ADSS) cable with extra aramid yarn in its outer jacket to provide its own support, eliminating the need for a messenger. ADSS cable is often used to span large distances when being supported off power utility towers. It is also popular when used near power utility lines as distribution plant.

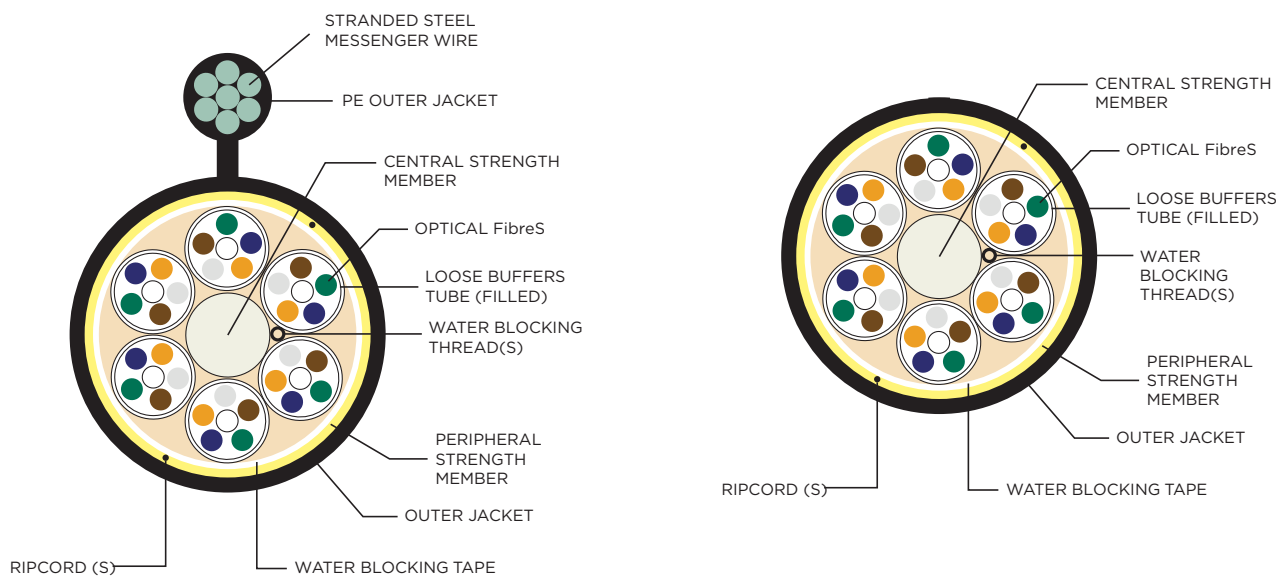

Figure 25- Two Main Self-Supporting Cables: Figure-Eight and ADSS Cables

Both types of cables are supported directly off their support structures (poles) and the tension in the catenary they form as they span the open space between supports must be adjusted to compensate for the weight of the cable, ice, snow, wind, and temperature effects. Cables need to be clamped in place at their dead-end starting point and raised to the next support structure. Their strength member that serves the purpose as a strand needs to be properly tensioned to the appropriate tension to resist the loading it will experience during service. Installation proceeds from span to span positioning the cable on the far support, then tensioning the cable for the loading and span length.

- ◆ Place the cable under the messenger strand using a strap and spacer approximately 14 inches from the centerline of the pole, or 2 inches from the lashing wire clamp, toward the pole.
- ◆ Attach the pulling lines to the lasher and pulling guide. The pulling lines can be attached to a vehicle or manually pulled to provide movement during the placing operation.
- ◆ Pull the cable lasher and its accessories with a constant speed and tension. Be vigilant looking for the lashing wire causing the optical cable to wrap around the strand. If this occurs, correct the situation. Cable feeding must be smooth.
- ◆ The moving vehicle (moving reel method) carrying the reel should stay close to the pole line and maintain alignment with the cable route as close to the pole line as possible during the cable placement operation while maintaining a distance of 50 feet in front of the cable
- ◆ Once the pole at the end of the first span has been reached, move the lasher to the messenger on the opposite side of the pole. Temporarily clamp the lashing wire to the strand. Complete the cable “drip loop” around the pole by attaching straps and spacers on both sides of the pole.

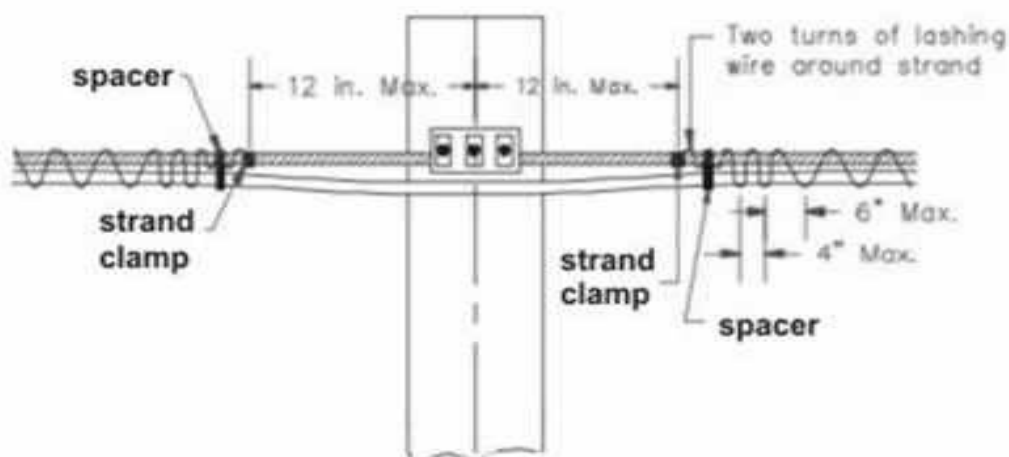

Figure 24- Intermediate Pole, Strand, and Clamp Attachment Hardware(RUS 1751F-635)

- ◆ After transferring the lasher to the far side of the pole, complete the permanent clamping of the lashing wire to the strand as was done at the start pole.

Repeat the procedure above for each pole line span until the entire run is permanently lashed and properly sagged.

- ◆ When required because of construction constraints, an optical cable may be lashed to the same suspension strand or as a new copper or an optical cable may be lashed over an existing cable to the same strand. The combined diameters of the two cables cannot exceed the diameter for which the lashing machine or supporting messenger strand was designed.
- ◆ To promote firm lashing when lashing two optical cables to the same strand, the diameter of first cable should not be more than twice the diameter of the second cable.
- ◆ If the diameter of a copper cable or of two copper cables exceeds 2.0 inches (51 mm), two nuts should be placed between the suspension clamp and washer to provide clearance between the pole and cables.
- ◆ The lashing operation in the moving reel placement method starts at the first pole (pole A) and moves toward the pole at the end of cable (pole B). The stationary reel method lashing is in the opposite direction, starting at the last pole from the cable pulling operation (pole B) and moving toward and ending at the first pole for the pulling operation (pole A).
- ◆ Before lashing new optical cables to an existing cable on the same strand, the existing lashing wire should be examined for corrosion, pitting, breakage, sharp points or edges, which could damage the new cable during installation. If the existing lashing wire is found to be severely corroded or pitted, broken, or containing sharp points or edges, the existing lashing wire should be removed before installation of the new cable. The removal of the existing lashing wire is infrequent.
- ◆ Begin the lashing operation by leaving enough slack cable at the beginning of the run, to reach down the pole to the splice location or end termination.
- ◆ Lift the lasher to the technician in a bucket truck at the first pole in the placing operation. Place the lasher and the aerial cable guide on the messenger strand and cable.
- ◆ If the moving reel method is being used, lift the cable to the technician in the bucket truck to position it in place under the messenger strand to begin the lashing operation. If a stationary reel method is used, the cable will already be in place to begin the lashing operation, by a technician in the bucket truck.
- ◆ Attach the lashing wire to the strand with a lashing wire clamp approximately 16 inches from the pole centerline.
- ◆ Position the cable in the cable guide and lasher as instructed by the instruction manual provided by the lasher's manufacturer.

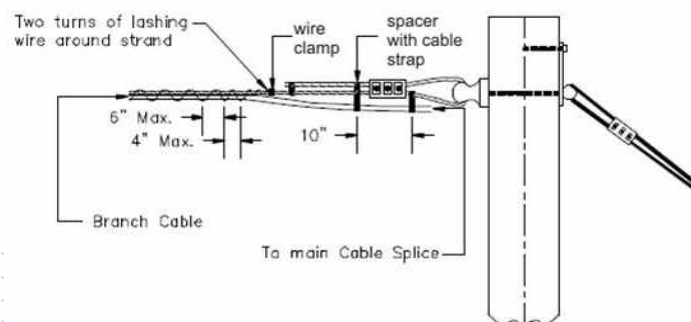

Figure 23- Typical Pole Attachment at Dead-End Pole using Moving Reel Method (RUS 1751F-635)

7.1 .4 Cable Lashing

- ◆ Lashing machines are manufactured to spin a small diameter wire around the cable and strand to couple the two units together. The size of the lashing machine used on the construction project is related to the outside diameter of the cable to be installed. The lashing machine should wrap the lashing wire around the cable and suspension strand in a counterclockwise direction. Where the construction must be performed on a slope, the lashing of the cable to the strand should be performed in the downhill direction.



Figure 21- Cable Lasher Used to Lash Fibre Cable to Messenger Strand, GMP

- ◆ Stainless steel lashing wire should be used to lash cable or cables to the messenger strand. The diameter of the lashing wire should be based on the outside diameter and weight of the cable to be installed and the size of the lashing machine.
- ◆ One or two types of lashing wire clamps are used in lashing cables to strands. The first type is a temporary or permanent clamp called the D Lashing Wire Clamp and the second, the E Lashing Wire Clamp for permanent clamping, shown in Figure 22.



Figure 22- D Lashing Wire Clamp (left) for Temporary or Permanent Strand/Lashing WireClamping and the E Cable Lashing Clamp (right) for Permanent Strand Clamping

- ◆ Guide drawings in RUS Bulletin 345-153 (RUS Form 515f) show how lashing wires are clamped in various situations. Lashing wire should be clamped at each side of each utility pole.
- ◆ Lashing wires should be spliced using stainless steel compression sleeves sized for the wire.
- ◆ When an optical cable is lashed at temperatures below 30°F (-1.1°C), the cable should be tensioned more than is required at higher temperatures. This will prevent bowing in hot weather.

- ◆ Position the aerial lift bucket at the pole from which the lashing will begin. The technician in the bucket should have 4 feet (1.2 m) access to either side of the lasher. The technician in the lift bucket should be the individual that is in charge of controlling the start of the placing operation.
- ◆ Before beginning the lashing, check to be certain there is sufficient cable at the final pole (pole B) to complete the splice and satisfy any slack cable requirements.
- ◆ Attach the lashing wire to the strand with a lashing wire clamp approximately 16 inches from the pole centerline.

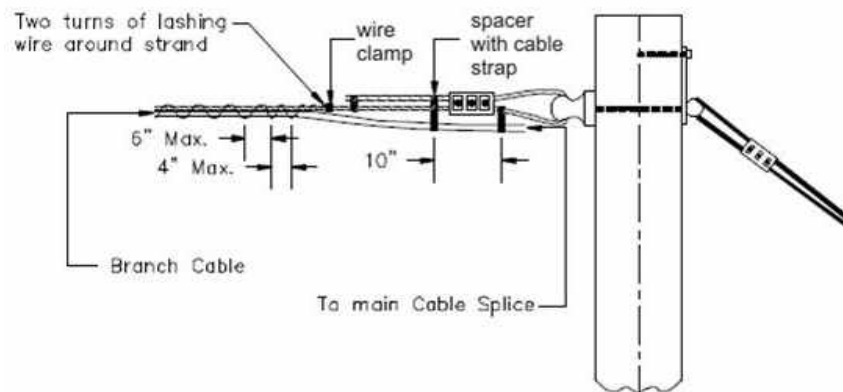

Figure 20- Pole Attachment at Dead-End Pole using Moving Reel Method (RUS 1751F-635)
Place the lasher and the aerial cable guide on the messenger strand.

- ◆ Place the cable under the messenger strand using a strap and spacer approximately 14 inches from the centerline of the pole, or 2 inches from the lashing wire clamp, toward the pole.
- ◆ Position the cable in the cable guide and lasher as instructed by the instruction manual provided by the lasher's manufacturer.
- ◆ Attach pulling lines to the lasher and pulling guide. The pulling lines can be attached to a moving reel vehicle to provide movement during the placing operation.
- ◆ Pull the cable lasher and its accessories at a constant speed and tension. Be vigilant looking for the lashing wire causing the Fibre optic cable to wrap around the strand. Cable feeding must be smooth.
- ◆ The vehicle pulling the lasher or the technician pulling the lasher should stay close to the pole line and maintain alignment with the cable route as closely as possible during the lashing operation while maintaining a distance of 50 feet in front of the lasher.
- ◆ Upon reaching each pole, stop the lashing operation. Transfer the lasher and its accessories to the messenger on the opposite side of the pole. Temporarily clamp the lashing wire to the messenger strand. Complete the cable "drip loop" around the pole by attaching straps and spacers on both sides of the pole.
- ◆ After transferring the lasher to the far side of the pole, complete the permanent clamping of the lashing wire to the strand.

The pull line is then used to pull the cable through the cable blocks below the messenger strand, see . Finally, the cable is lashed to the messenger strand. The lashing process begins at the leading end of the cable and proceeds back towards the cable reel.

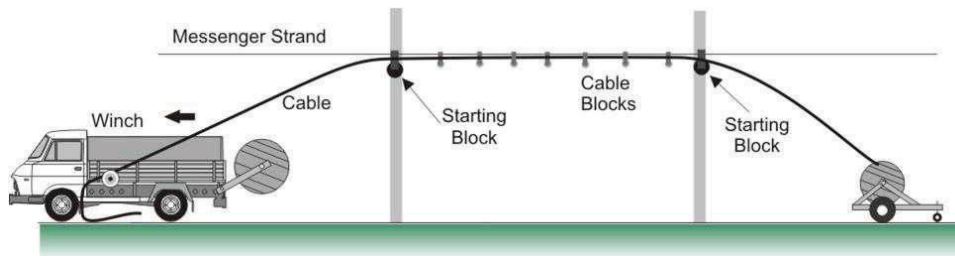

Figure 18- Stationary Reel Method, Cable Being Pulled into Cable Blocks Prior to Lashing Operation

- ◆ The stationary reel method, shown in and , consists of a cable reel, a suitable device for supporting the cable reel, and rollers attached to the strand to support the cable during the installation.

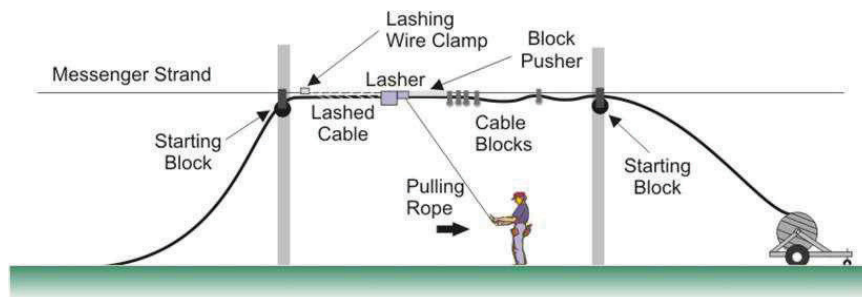

Figure 19- Stationary Reel Method Lashing Aerial Cable to Messenger Strand Being Pulled in the Opposite Direction of the Cable Placing Operation

- ◆ When using the stationary reel method, the pulling tension and bending radius of the optical cable should be kept within its stated limits. Rollers used in the stationary reel method should be installed on the strand at a spacing of approximately 35 feet (10.67 m). Rollers should also be installed at all bends in excess of 45 degrees from normal.
- ◆ The cable should be pulled over the rollers in the stationary reel method using either a winch linewire rope approximately 0.25 inch (6.4 mm) in diameter or synthetic rope approximately 0.5 inch (12.7 mm) in diameter. Larger diameter starting blocks should be used at both ends of the cable placement operation.
- ◆ Since optical cables are typically manufactured and installed in long lengths, special consideration must be given to reel placement to eliminate or reduce the extra effort required to figure-eight the cable at a mid-run location or provide a series of mid-assist pulls for both the moving and stationary reel installation methods.
- ◆ This procedure uses an aerial lift or bucket truck, winch truck, and cable reel trailer.

7.1 .3 Stationary Reel Method

The stationary reel placing method is often used when the cable route being placed is crossed by existing cables or other obstructions. The method used should also be based on the experience and equipment available to the installer. The stationary reel placing method requires a series of temporary cable blocks to be installed on the messenger strand. It requires two separate operations:

1. The cable is pulled into place for the cable run beneath the messenger strand and supported by cable blocks hanging off the messenger strand.
2. The cable is lashed to the messenger strand beginning at the cable end and moving in the opposite direction of the (step 1) cable placement and ending at the stationary reel location.

A pull line is placed through the blocks and attached to the leading end of the cable using a breakaway swivel and a cable pulling-grip.

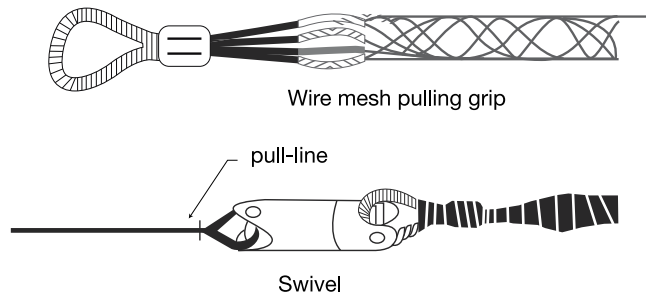

Figure 14- Pulling Hardware Required to Place Cable onto Cable Blocks During the First Stage of the Stationary Reel Placing Method

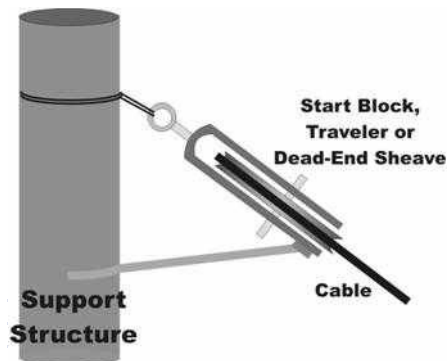

Figure 15- Starting Block for Cable Placement through Cable Blocks Used at First and Last Pole

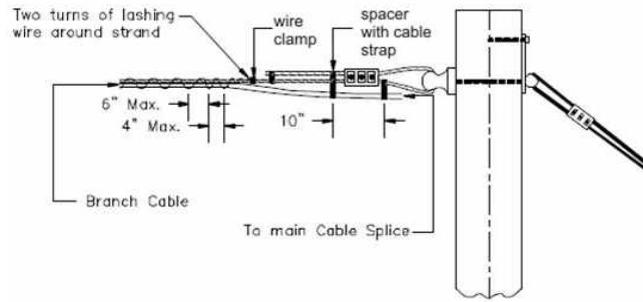

Figure 13- Typical Pole Attachment at Dead-End Pole Using Moving Reel Method (RUS 1751F-635)

- ◆ Place the lasher and the aerial cable guide on the messenger strand.
- ◆ Raise the cable end to the technician in the bucket truck at strand level using a pole mounted cable lifter.
- ◆ Place the cable under the messenger strand using a strap and spacer approximately 14 inches from the centerline of the pole, or 2 inches from the lashing wire clamp, toward the pole.
- ◆ Position the cable in the cable guide and lasher as instructed by the instruction manual provided by the lasher's manufacturer.
- ◆ Attach pulling lines to the lasher and its pulling guide. The pulling lines can be attached to the moving reel vehicle to provide movement during the placing operation.
- ◆ Pull the cable lasher and its accessories with a constant speed and tension. Be vigilant looking for the lashing wire causing the Fibre optic cable to wrap around the strand. If this occurs, correct the situation. Cable feeding must be smooth.
- ◆ The moving vehicle carrying the reel should stay close to the pole line and maintain alignment with the cable route, as close to the pole line as possible, during the cable placement operation while maintaining a distance of 50 feet in front of the cable.
- ◆ Upon reaching each pole, stop the vehicle. Transfer the lasher and its accessories to the messenger on the opposite side of the pole. Temporarily clamp the lashing wire to strand on the near side of the pole. Complete the cable "drip loop" around the pole by attaching straps and spacers on both sides of the pole.
- ◆ After transferring the lasher to the far side of the pole, complete the permanent clamping of the lashing wire to the strand on both sides of the pole.

Repeat the procedure above for each pole line span until the entire run is permanently lashed and properly sagged.

In the moving reel or drive-off installation method, the cable is payed off its reel, raised to strand level, and lashed to the strand as the placement vehicle as it reaches the next pole in each span. This method requires vehicle access to the placement side of the pole line, and the cable route must be away from tree limbs, guy wires, and other obstructions. If the cable route has significant elevation changes, it is preferable to lash downhill.

The moving reel method provides greater productivity and is less costly than the stationary reel methods. It is a simpler procedure that uses less hardware in a single step procedure. In addition, fewer technicians are required to complete the installation.

- ◆ Since optical cables are typically manufactured and installed in long lengths, special consideration must be given to reel placement to eliminate or reduce the extra effort required to figure-eight the cable at a mid-run location or provide a series of mid-assist pulls for both the moving and stationary reel installation methods.
- ◆ Begin the installation by unreeling sufficient cable to reach from the messenger strand level to the splicing location (probably a vehicle on the ground), plus 16 feet (5 m). This lead-in tail should be safely stored at the starting pole. In addition, unspool enough slack cable to assure that the cable's minimum bend radius is not exceeded when the cable is raised to the strand level. Generally, the reel-carrying vehicle should be approximately 50 feet (15 m) ahead of the lasher.

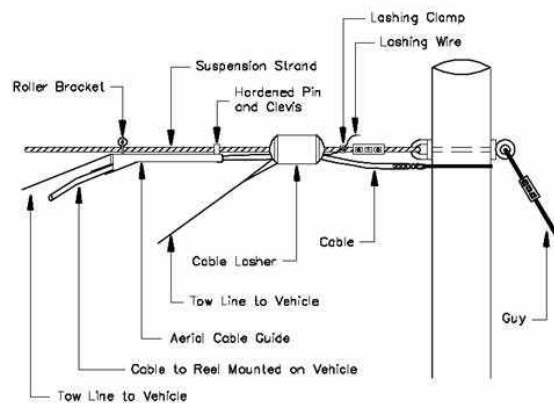

Figure 12- Start Up Configuration for Moving Reel Aerial Placement Method (RUS 1751F-635)

- ◆ This procedure uses an aerial lift or bucket truck and a moving reel truck.
- ◆ Position the aerial lift bucket so that the crew member working in it has a 4 feet (1.2 m) access to either side of the lasher. The technician in the lift bucket should be the key individual that is in charge of controlling the placing operation.
- ◆ The cable is paid off the top of its reel on the moving placement vehicle, raised to strand level, and lashed to the messenger strand as the placement vehicle moves along each span.
- ◆ No cable blocks or other temporary support hardware are used with the moving reel method. As compared to the stationary reel method which requires several passes along the cable route to complete the cable installation, the moving reel method is completed in one pass.
- ◆ Attach the lashing wire to the strand with a lashing wire clamp approximately 16 inches from the pole centerline.

Aerial micro-ducts are placed exactly as standard size aerial optical cable would be placed, using either the stationary reel method or the moving reel method. The net result is micro-ducts, either in inner ducts, overcased units, or uncased are lashed to messenger strands whenever aerial micro-duct cables are being used.

The micro-ducts are lashed to the messenger strand between the two pole supports that bound the portion of the aerial cable route. Tails approximately 40 to 50 feet long should be provided on each end of the lashed micro-duct aerial section. The tails will be used as lead-in and lead-out pathways for the jetted cable. Once the cable is in place the micro-duct can be trimmed at the two bounding poles and held in position using plastic banding that would be used with plastic spacers. The excess lengths of micro-duct can be removed from each tail. The trimmed micro-duct tails should be plugged to prevent water, dirt, and animals from entering the micro-duct.

Micro-duct systems have been used successfully as a standard cable system throughout the Americas and the remainder of the world for the last decade.

7.3.2 Micro-Duct Cables

STL Micro DUCT-LITE™ optical cables are a compact optical cable family designed to be used as part of the micro-duct system. They are cables with diameters ranging from 5.8mm to 18mm with compact Fibre counts ranging from 12 Fibres to 576 Fibres. Currently, STL's Micro DUCT-LITE Fibre optic cable series is all multiple tube construction with color coded individual buffer tubes and Fibres, (see Figure 3).

The STL Micro DUCT-LITE cable is designed especially for enhanced jetting performance and can be installed in currently occupied ducts. These cables will continue to meet future telecommunication needs, as well. Dry core, small diameter and reduced weight make them ideal for jetting long distances. Water blocking compounds in the buffer tubes and core provide longitudinal water protection. Multiple tube designs allow for easy mid-span access. The cable series uses a specially developed low shrinkage, highdensity polyethylene sheath with a nominal thickness of 0.5 mm. The STL Micro DUCT-LITE cable jacket that is made from a special low friction, high density polyethylene (HDPE) that has a surface finish that is intended to create sufficient air drag during air jetting to lift the cable off the inside wall of the microduct and provide a uniformly distributed assisting placing force along the outer perimeter of the cable.

The following effects contribute to the placing force build-up in the micro-duct cable as it is placed into micro-duct:

- ◆ **Cable weight (gravity).** This results in a placing force that is proportional to the installed weight of the cable which is directly related to the cable size, design, and the length of the cable.
- ◆ **Coefficient of friction.** The material property that relates the normal force to frictional force between cable and duct (or adjacent cable when several cables are present in the same duct). The coefficient of friction affects the cable tension linearly in straight runs. In bends and undulations of the duct, the tensile pulling force increases exponentially with respect to the undulation's curvature and the coefficient of friction. This effect is known as the capstan effect. It can dominate most cable placements.
- ◆ **Cable tensile force.** The resulting placing load for a cable is the combination of cable weight, curvature of the bends, location of the bends, coefficient of friction, and weight of cable (unit weight and length). The total cable placing force required to place the cable must not exceed the rated cable tensile strength.

- ◆ **Cable compressive force.** The cable can buckle from the compressive force a cable pusher exerts and/or become crushed from additional sidewall forces that build up on the inside of a bend. This can also lead to a pulling force built-up that limits the distance it can be pushed. If a cable pusher is used to assist cable placing as it enters the sub-duct and if it continues to push even after a cable jam occurs, the compressive force could cause the cable to buckle, unless the placing engine is adjusted to stop pushing when cable compressive load reaches a set safe level.
- ◆ **Cable stiffness in bends and undulations in the duct trajectory.** The greater the cable stiffness, the larger the frictional force from cable stiffness in bends and undulations in the duct.

7.3.3 Jetting: Micro-Duct Cable Placing Method

The force to install a cable by jetting is caused by sidewall forces between cable and micro-duct, the stiffness of the cable, and the friction coefficient between the interacting materials. Micro-ducts and microduct cables are designed to reduce the surface contact forces between the cable and its supports, lower the coefficient of friction between interacting materials, and optimize the Fibre capacity of the available space. The placing method discussed in this section has been developed to enable standard size optical cables and micro-duct cables to be placed efficiently, safely, and economically.

- ◆ **Jetting (blowing)**– A system used in previously installed aerial micro-ducts using air pressure that is similar to that used in longer lengths of underground plant. Standard optical cables and/or microduct cables can be placed using jetting. Jetting is most effective in smaller ducts of 50 mm diameter or less (micro-ducts). It is possible to place micro-duct cable using jetting in continuous lengths of 4,000 to 6,000 feet, depending upon the geometry of the right-of-way

7.3.3.1 Pre-Jetting Procedures

- ◆ The micro-duct system needs to be checked to be sure that it is air tight. If leaks are present they need to be fixed or else pulling distance will be sacrificed. The cable diameter needs to be measured at several locations along the cable length with sufficient accuracy and at enough locations to assure the correct size is selected for the cable dies of the pusher/blower placing engine to properly fit the cable.
- ◆ The placing equipment shall be setup to provide direct and smooth passage of the cable into the micro-duct. All equipment shall be cleaned and adjusted to assure that all parts are properly sized to grip and/or pass the cable that is being installed.

Micro-ducts, innerducts, and feed tubes shall be adjusted to keep bends in the cable from violating the cable minimum bend radius. If macro-duct is being placed, care must be taken not to kink, distort, or crush the duct. The micro-duct manufacturer's recommended minimum diameter shall be maintained, if no diameter is recommended, use the minimum diameter recommended for the cable.

Micro-duct under no load, Minimum bend radius $\geq 15 \times$ Cable Diameter
Micro-duct under load, Minimum bend radius $\geq 20 \times$ Cable Diameter

- ◆ An air cooler should be considered to cool the compressed air between the compressor and the duct, especially if the ambient air temperature exceeds 80° F. It is possible on hot days for the compressed air to reach a temp of 200° C, if an air cooler is not used. The air in the micro-duct should never exceed the maximum cable installation temperature, typically 140° F. At temperatures above the cable's maximum installation temperature, the cable's outer jacket can soften causing an increase in the coefficient of friction between cable and duct, resulting in an increase in placing force and limiting the placing distance.
- ◆ The placing operation requires good communications between all locations along the right-of-way. Radios are usually required to provide the level of communications required. Before placing is started, the communications system shall be tested.
- ◆ Remove 1 or 2 cm of the micro-duct cable's outer jacket. Use a 5 minute epoxy to seal off the cable end and also to mechanically bond all portions of the cable together, i.e., jacket, core, buffer tubes, Fibre, and central strength member. Epoxy should be applied to cause a smooth blunt end without increasing the diameter of the cable.
- ◆ The cable jetting machine will have a pushing tread on it to provide a pushing force to the cable to assist it into the micro-duct as it is propelled forward with the air jetting. The pushing force could conceivably cause the cable to buckle if the jetting fails or if the cable jams in the micro-duct. The buckling force of the cable should be determined before the placing operation begins. Install the cable in the placing engine. Block the forward motion of the end of the cable. Allow the placing engine to push the cable until it buckles or kinks. Record the force at which the action occurs. Set the push limiter on the placing engine to 75% of the measured buckling load. This should keep the micro-duct cable from buckling if a jetting problem develops.
- ◆ Set the maximum tensile force exerted by the placing engine to 80% of the maximum placing load for the cable to assure that the cable's maximum placing load will not be violated.
- ◆ Polywater offers the micro-duct cable placing lubrication estimate shown in to place micro-duct cable in various size micro-ducts. Pour approximately 75% of the lubricant indicated directly into the micro-duct ahead of the missile with the remainder of the lubricant being placed on the cable during the placing operation. Note, the actual quantity of lubrication used on any placing operation varies and is dependent upon the size, condition, and wall type of the micro-duct and the material in the duct and cable jacket.

Micro-Duct Size (MM) (OD/ID)	Amount of Lubrication Required Per 100 feet
14/12 mm	0.30 fl. oz (9 ml)
12/10 mm	0.25 fl. oz (7 ml)
10/8 mm	0.20 fl. oz (5 ml)
8/ 6 mm	0.15 fl. oz (4 ml)
7/5 mm	0.13 fl. oz (4 ml)
5/3.5 mm	0.09 fl. oz (3 ml)
4/3 mm	0.08 fl. oz (2 ml)

Table 7- Approximate Volume of Lubrication Required For Cable Jetting in Various Size Micro-Ducts

7.3.4 Micro-Duct Cable Jetting

Before the cable placing operation begins, the micro-duct system should be checked to be assured the cable's minimum bend radius is not violated during handling, feeding, placing, and final positioning. The equipment and all pressure fittings should be checked. The placing engine should be checked to confirm that the tension and compression limits matching the cable being placed have been properly and accurately set. Radios should be checked to confirm that all manned positions along the right-of-way are in communications and prepared to start the placement. Figure 45 shows a typical unassisted micro-duct cable jetting operation.

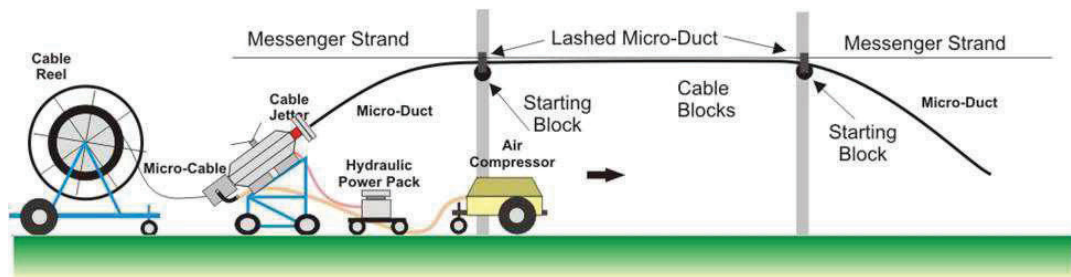

Figure 45- Cable Jetting Schematic Showing Aerial Placement in Sub-Duct Without Intermediate Assist

Air pressures and hydraulic pressures shall be set according to the placing engine manufacturer's instructions. The operation of the placing engine shall follow its manufacturer's instructions.

The placing operation shall begin slowly and continue at the slow speed until it is clear that it is progressing smoothly. The placing speed can be increased gradually until the operation reaches a fast, but completely under control speed. Speeds from 100-190 ft/min or more can be reached depending upon the experience of the crew and the geometry of the placing route. STL and the placing engine manufacturer recommend that the placing operation should be performed at a safe and controllable speed.

If the placing operation is too difficult to accomplish in a single, unassisted operation, bidirectional placement (figure-eighting) can be considered. Individual aerial segments in the bidirectional placement method need to be kept a bit shorter in length than the unassisted placement route. As a rule of thumb, placing runs should be limited to 1.5 km or shorter.

Since the intermediate aerial assist method causes the micro-duct system to be discontinuous at the figure-eighting location, each of these discontinuous duct segments need to be lubricated independently, i.e., they need to have lubrication applied ahead of the cable, and then on the cable as it passes into the duct segment. Each placing engine in an intermediate assist procedure needs to be adjusted with the mechanical limitations determined for the cable being placed, i.e., maximum compression and tensile force.

Additional Information

If there are additional questions on this topic or other Fibre optic issues, please contact STL at:

Contact Information

telecom.sales@STL.com

www.STLtechnologies.com